

Variable speed drives Altivar Machine ATV320

Catalog

September 2017



Quick access to Product information

Select your Catalog, your Training

Digi-Cat

The complete digital catalog for industrial automation



Makes your choice easy every day, everywhere!



With just 3 clicks, you can reach the 7,000 pages of the Industrial Automation & Control catalog, in both English and French.

- Digi-Cat is available on a USB key (for PC). To get your Digi-Cat, please contact your local center
- Download Digi-Cat from this address:

<http://digi-cat.schneider-electric.com/download.html>

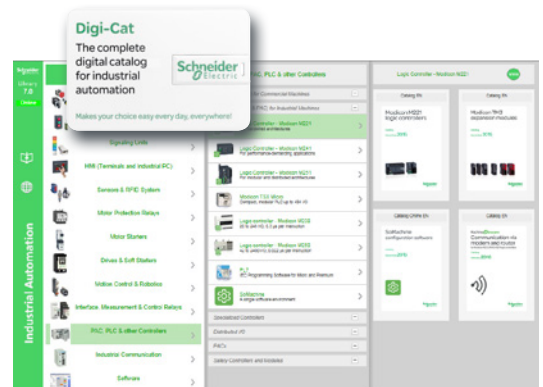

Find your training

- Find the right training for your needs
- Locate the training center with the selector tool, using this address:

<http://www.schneider-electric.com/b2b/en/services/training/technical-training.jsp>

then click on

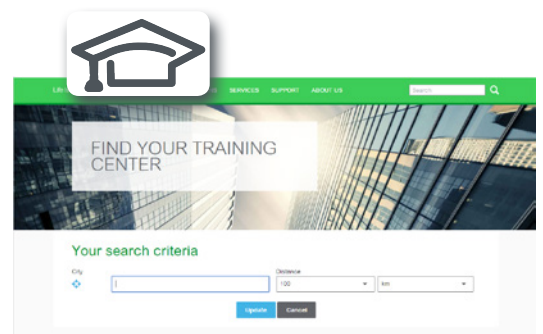
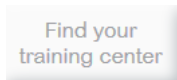

Life Is On



General contents

Altivar Machine ATV320 variable speed drives

Altivar Machine offer for Original Equipment Manufacturers (OEM) page 2

■ Altivar Machine ATV320 Variable speed drives

□ Machine solution.....	page 4
□ Applications	page 5
□ Presentation	page 5
□ Innovative functions.....	page 7
□ The offer	page 9
□ Description	page 11
□ Standards and certifications	page 11
□ References	
- Drives with compact control block.....	page 12
- Drives with book control block	page 13
- Accessories	page 14
- Mounting accessories.....	page 15
- Replacement parts	page 15

■ Options

□ Dialog tools and configuration tools	
- DTM.....	page 16
- Simple Loader and Multi-Loader configuration tools.....	page 17
- Remote display terminal	page 18
- Remote graphic display terminal, accessories.....	page 19
□ Combinations: options for ATV320 drives	
- Drive with compact control block	page 20
- Drive with book control block	page 22
- Option modules	page 22
□ Braking resistors.....	page 24
□ Line chokes	page 26
□ Motor chokes	page 27
□ Additional EMC input filters.....	page 28
□ Option module adapter	page 30
□ Speed monitoring module.....	page 31

■ Communication buses and networks

□ Presentation	page 32
□ Functions	page 33
□ References	
- Modbus serial link	page 33
- CANopen machine bus.....	page 34
- Modbus TCP network and EtherNet/IP network	page 36
- PROFIBUS DP, DeviceNet bus, EtherCAT bus, POWERLINK network, ProfiNet network.....	page 37

■ Motor starters

■ Dimensions

□ Altivar Machine ATV320 Variable speed drives	
- Drives with compact control block	page 42
- Drives with book control block.....	page 44
□ Line chokes, Motor chokes, Braking resistors, Additional EMC input filters.....	page 45

■ Product reference index.....

Application segments	General
	Specific

Material handling, packaging, textiles, hoisting, mechanical actuators, material working
Conveyors, carton packers, gantry cranes, woodworking, metal processing, fans, etc.



Degree of protection	
Power range for 50..60 Hz supply	Single-phase 200...240V Three-phase 200...240V Three-phase 380...480V Three-phase 380...500V Three-phase 525...600V

IP20	IP20
0.18...2.2 kW/0.25... 3 HP	0.18...2.2 kW/0.25... 3 HP
0.18...15 kW/0.25...20 HP	-
-	-
0.37...4 kW/0.5...5 HP	0.37...15 kW/0.5...20 HP
0.75...15 kW/1...20 HP	-

Drive	Output frequency
	Control type Asynchronous motor
	Synchronous motor
	Motor sensor Integrated as an option
	Overload torque performance

0.1...599 Hz	-
U/F ratio (2 points, 5 points, energy saving, quadratic), Flux vector control without sensor (Standard and Energy saving)	
Vector control without sensor	
-	
RS422 (speed monitoring)	
Up to 200% Tn in an open loop	

Functions	Advanced functions
	Integrated safety functions
	Number of preset speeds

<ul style="list-style-type: none"> Control of asynchronous and synchronous motors; including IE2, IE3 and PM motors in open loop MachineStruxure integration in SoMachine Operation in Velocity mode and Torque control (with current limitation) Customizable and flexible application functions with ATV Logic (up to 50 function blocks) Numerous application functions for targeted application segments Embedded safety functions dedicated to targeted application segments 	
STO (up to SIL3 / PL _e), SS1, SLS, SMS, GDL	
16	

Number of integrated I/O	Analog inputs
	Digital inputs
	Analog outputs
	Digital outputs
	Relay outputs
	Safety function inputs

3: 1 Bipolar differential ±10 V, 1 with Voltage ±10 V and 1 with current (0-20 mA)	
6: 4 configurable (positive or negative logic), 1 with PTC probe input, 1x20kHz pulse input	
1: Configurable as voltage (0...10 V) or current (0-20 mA)	
1: Configurable as voltage or current	
2: 1 with NO/NC contacts and 1 with NC contacts	
1 + 4: 1 with STO and 4 configurable for safety functions from digital inputs	

Optional I/O extension module

-

Communication	Integrated
	Optional

Single port compatible with CANopen and Modbus Serial line
Ethernet IP and Modbus TCP, CANopen RJ45 Daisy Chain, Sub-D, and screw terminals, PROFINET, Profibus DP V1, EtherCAT, and DeviceNet

Configuration and runtime tools

integrated Display, DTM (Device Type Manager), SoMove software, simple loader (optional) and multiloader (optional)

Standards and certifications

IEC 61800-5-1, IEC 61800-3 (environments 1 and 2, category C2), UL 508C, EN 954-1 category 3, ISO/EN 13849-1/-2 category 3 (PL e), IEC 61508 (parts 1 & 2) SIL 2 level, draft standard EN 50495E IEC 60721-3-3, classes 3C3 and 3S2
CE, UL, CSA, RCM, EAC, ATEX

References

ATV320●●●●●C | **ATV320●●●●●B**

Packaging, material handling, material working, hoisting
Palletizers, shrink wrapping machines, cardboard box folding machines, standard cranes, automatic storage systems, grouping conveyors, slitters, etc.



IP20	IP20	IP20
-	-	-
-	-	-
0.75...22 kW/1...30 HP	0.75...22 kW/1...30 HP	30...75 kW/40...100 HP
-	-	-
-	-	-

0.1...599 Hz	Voltage vector control without sensor, Current Vector control with Sensor, U/F 5 points, Energy saving mode	
Open-loop synchronous motor control (with and without stall monitoring), closed-loop synchronous motor control, synchronous reluctance motor control		
RS422 Incremental, Sincos		
Digital (RS422 incremental, EnDat2.2, SSI), analog (sin/cos 1Vpp), resolver		
Up to 220% Tn in open loop or closed loop control		Up to 180% Tn in open or closed loop control

<ul style="list-style-type: none"> Control of asynchronous, synchronous, special motors including all efficiency classes, PM motors, torque motors, conical sliding rotor, reluctance Advanced MachineStruxure integration in SoMachine Operation in Velocity mode, Torque mode Possibility of adding I/O expansion cards, or optional encoder feedback modules Numerous application functions for targeted application segments Very dynamic motor control performance (up to 400 Hz speed bandwidth) and cyclic application task (1 ms) Possibility of Master/Slave daisy chain through PTO/PTI 		
<ul style="list-style-type: none"> Integrated Ethernet IP and Modbus TCP dual port, cyber security (Achilles Level 2) Via integrated web server continuous and real-time application data with customizable dashboards Master/Slave drive-to-drive link via Ethernet 		
STO SIL3/PL _e with dual input		
16		

2: 1 configurable (voltage/current/thermal probe) and 1 with bipolar differential ±10 V ---	3: Configurable as voltage (0...±10 V ---) or current (0-20 mA/4-20 mA), including 2 for probes (PTC, PT100, PT1000, or KTY84)
5 + 2: 5 configurable (positive or negative logic) and 2 which can be configured as digital input or output	8: Configurable (positive or negative logic)
1: Configurable as voltage (0...10 V ---) or current (x...20 mA)	2: Configurable as voltage (0...10 V ---) or current (x...20 mA)
2: Assignable	1: Assignable
2: 1 with NO/NC contacts and 1 with NC contacts	3: 1 with NO/NC and 2 with NO contacts
2: STO_A\, STO_B\ for STO safety function	2: STO_A\, STO_B\ for STO safety function

I/O expansion module and/or relay expansion module

2 ports for Modbus serial line	Dual port for Ethernet IP/Modbus TCP, 2 ports for Modbus serial line
CANopen RJ45 Daisy Chain, Sub-D, and screw terminals, PROFINET, Profibus DP V1, EtherCAT, and DeviceNet	

Status display LEDs, Display (optional), DTM (Device Type Manager), SoMove software

UL508C/UL61800-5-1, EN/IEC 61800-3, Environment 1 category C2, EN/IEC 61800-3, Environment 2 category C3, EN/IEC 61800-5-1, IEC 60721-3-3, classes 3C3 and 3S3, IEC 61508, IEC 13849-1, Green Premium, Reach/RoHS

CE, UL, CSA, TÜV, Green Premium, RoHS EU, China

ATV340●●●N4 | **ATV340●●●N4E**

Machine solution

The Altivar Machine ATV320 is an IP 20 variable speed drive for three-phase synchronous and asynchronous motors, and incorporates functions suitable for the most common applications, including:

- Material handling
- Packaging
- Textiles
- Hoisting
- Mechanical actuators
- Material working

The Altivar Machine ATV320 series is focused on easy integration for simple and advanced machine requirements with proven motor control and connectivity.

It offers enhanced automation capabilities and performance for industrial machine applications:

- Effective control of asynchronous and permanent magnet motors
- Complete integration into any system architecture (Ethernet, CANopen, Profibus, etc.)
- Compact and book format for integration in a variety of different cabinet types
- Integrated safety function for compliance with functional safety standards
- Enhanced resistance to polluted atmospheres

By taking account of constraints on product setup and use right from the design stage, Schneider Electric simplifies the integration of the Altivar Machine ATV320 drive into industrial machines. It features more than 150 functions. It is robust, easy to install, and compliant with the Machinery Directive 2006/42/EC.

Schneider Electric's MachineStruxure solutions provide abundant ready-to-use, PLCopen-compliant libraries. SoMachine can be used to develop, configure, and set up an entire machine in a single software environment. Using FDT/DTM technology, it is possible to configure, control, and diagnose Altivar Machine ATV320 drives directly in SoMachine and SoMove software by means of the same software brick (DTM).

With seamless integration under this platform, Altivar Machine ATV320 benefits from the advantage of shorter engineering and design times. Optional Ethernet-based communication capability makes it accessible to real-time production data at any level of the automation system via a web server.

Applications

Altivar Machine ATV320 drives incorporate functions suitable for the most common applications, including:

Material handling

- Small conveyors
- Large conveying systems
- Turntable conveyors, etc.

Packing and packaging machines

- Small bagging machines
- Labeling machines
- Carton packers, etc.



Material handling application



Packing and packaging machines



Textile application

Applications (continued)

Textiles

- Rapiert loom machine
- Knitting machine
- Web cutting



Hoisting application

Hoisting

- Pick and place
- Industrial elevators for manufacturing
- Gantry cranes



Mechanical actuator application: pump

Mechanical actuators

- Pumps
- Fans
- Compressors



Material working application

Material working

- Woodworking machinery
 - Saws
 - Gummers
 - Planers
- Metal processing
 - Bending presses
 - Welding machines
 - Cutting machines
 - Grinding

Special machines

- Mixers
- Kneaders
- Transfer machine

Presentation

The Altivar Machine ATV320 drive is a variable speed drive for three-phase asynchronous and synchronous motors from 0.18 to 15 kW.

The Altivar Machine ATV320 drive is robust, simple to commission, and easy to integrate into different machine layouts and cabinets. It can also be integrated into commonly used automation architectures. Altivar Machine ATV320 variable speed drives are particularly suitable for applications involving simple industrial machines.

Furthermore, Altivar Machine ATV320 embeds many practical functions so that advanced application requirements can be covered. Altivar Machine ATV320 is designed to improve machine performance and increase machine availability while reducing the total machine cost.

Flexible

There are 2 different formats for products: book and compact:

- The book format, 45 and 60 mm (1.77 and 2.63 in.) wide, is designed to be mounted side-by-side to save significant space on the installation foot print (1).
- The compact format, 72 to 180 mm (2.83 to 7.08 in.) wide, is designed to be integrated in compact electrical cabinets (200 mm (7.87 in.) cabinet depth or less) or mounted directly on the machine frame.
- Altivar Machine ATV320 offers variety of supply possibilities:
 - 200-240 V single phase: supplied products are up to 2.2 kW,
 - 200-240 V three phase, 380-500 V three phase, and 525-600 V three phase: supplied products are up to 15kW.

Advanced connectivity

Advanced connectivity allows the Altivar Machine ATV320 to operate in commonly used automation architectures; CANopen and Modbus RTU communication protocols are embedded and various communication fieldbus options are offered based on:

- Ethernet, Modbus TCP, EtherNet/IP, Profinet, EtherCAT
- Serial, CANopen (Daisy Chain), ProfibusDP

Robust design

Altivar Machine ATV320 variable speed drives can operate in harsh environment conditions:

- Up to 50 °C/122 °F without derating
 - Up to 60 °C/140 °F with derating without the need for an additional fan
- The printed circuit boards are coated according to IEC 60721-3-3 class 3C3 for industrial environments and 3S2 for solid particles.

Effective motor control

Control of both asynchronous and synchronous motors is both simple and effective. Altivar Machine ATV320 offers +/- 10% accuracy of motor slip in open-loop control with asynchronous motors.

Integrated safety functions and control system functions

As standard, Altivar Machine ATV320 drives provide innovative features including integrated safety functions and control system functions to meet the requirements of specialized applications.

The comprehensive integrated safety function solution includes the Safe Torque Off (STO) function for simple requirements, as well as more advanced monitoring functions such as Safely Limited Speed (SLS), Safe Maximum Speed (SMS), Guard Door Locking (GDL), and Safe Stop 1 (SS1).

(1) The book format products are up to 4 kW and compatible supply voltages are 200-240V single phase and 380-500V three phase.

Innovative functions (1)



Example of an application requiring the use of safety functions

Safety functions

The Altivar Machine ATV320 range of variable speed drives provides integrated safety functions (according to standard IEC 61508) comparable with performance level “e” (PL e) according to standard ISO/EN 13849-1-2.

The Altivar Machine ATV320 drive software includes 5 safety functions that help machines meet safety requirements, whether or not they are used in conjunction with a Preventa safety module (2):

- STO: Safe Torque Off
- SLS: Safely Limited Speed
- SS1: Safe Stop 1
- SMS: Safe Maximum Speed
- GDL: Guard Door Locking

These safety functions are configured using SoMove configuration software. For more information, please refer to the SoMove catalog available on our website www.schneider-electric.com.

Note: To set up the safety functions, please refer to the “Altivar Machine ATV320 Safety Functions Manual” available on our website www.schneider-electric.com.

ATV Logic

ATV Logic is used to adapt Altivar Machine ATV320 variable speed drives to specific applications by means of customizable integrated control system functions.

The integrated control system functions featuring ATV Logic can be used to perform simple operations without adding further devices, which reduces costs. ATV Logic is programmed via the SoMove configuration software (refer to the SoMove catalog available on our website www.schneider-electric.com) and provides access to the following functions:

- Arithmetical operations, Boolean operators, counters, timers, etc.
- Programming of up to 50 functions by an automated sequence
- Access to the drive's internal variables

Functions dedicated to synchronous motors

Altivar Machine ATV320 variable speed drives integrate new functions for synchronous motors that are suitable for the majority of commercially-available motors.

- Simplified setting due to the reduced number of configuration parameters (4 maximum)
- Autotuning of the drive/motor combination
- High-frequency injection for high performance in open-loop mode

Application functions

Altivar Machine ATV320 variable speed drives feature 150 functions, including:

- Configurations: standard or customizable
- Application-specific functions for material handling, textiles, hoisting, mechanical actuators
- Adjustable switching frequency (adjusted motor current, reduced motor noise)
- Adjustable monitoring function to create “My Menu” function to obtain user-specific monitoring
- Ability to upload/download drive configurations with the power off



Example of an application (scrolling billboard) requiring a typical ATV Logic sequence

Usage Examples (functions/applications)

Functions	Applications				
	Handling	Conveying	Packing	Woodworking machinery	Metal processing
Integrated safety functions					
Communication buses and networks					
Fast response time					
Control profile for synchronous motors					
Application-specific functions					
		Typical use			Not applicable

(1) Non-exhaustive list; please consult our website www.schneider-electric.com.

(2) Please refer to our web site <http://www.schneider-electric.com/machinesafety>

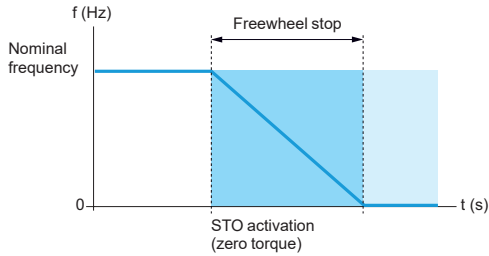

Activation of the STO safety function

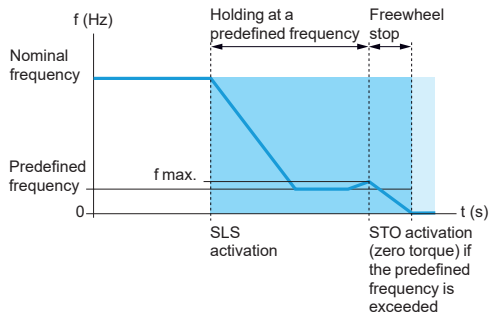

Activation of the SLS safety function

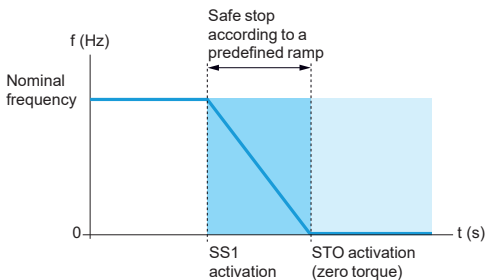

Activation of the SS1 safety function

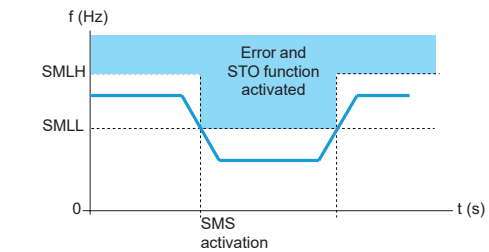

Activation of the SMS safety function

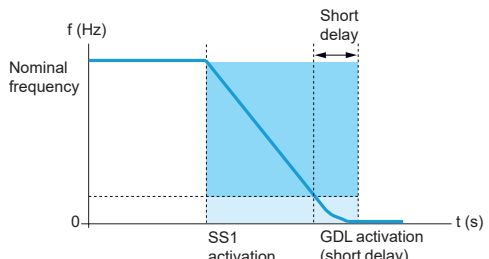

Activation of the GDL safety function (example of stop type SS1)

Integrated safety functions (1)

Altivar Machine ATV320 drives include 5 safety functions:

- STO: Safe Torque Off (2)
- SLS: Safely Limited Speed
- SS1: Safe Stop 1
- SMS: Safe Maximum Speed
- GDL: Guard Door Lock

These functions are certified in accordance with IEC61508 Ed.2 "Functional safety of electrical/electronic/programmable electronic safety-related".

These integrated functions make it possible to:

- Simplify setup of machines that require a complex safety related device
- Improve performance during maintenance by reducing machine or installation downtime

Note: Some applications may require the addition of external Preventa safety modules (2).

Safe Torque Off (STO) safety function (1)

This function brings the machine safely into a no-torque state and/or prevents it from starting accidentally.

Safely Limited Speed (SLS) safety function (1)

The SLS integrated safety function can be initiated by activation of safety function inputs. This function prevents the motor from exceeding the specified speed limit. If the motor speed exceeds the specified speed limit value, safety function STO is triggered.

Safe Stop 1 (SS1) safety function (1)

The SS1 integrated safety function causes a category 1 safe stop. This function monitors the deceleration according to a dedicated deceleration ramp and safely shuts off the torque once standstill has been achieved.

Safe Maximum Speed (SMS) safety function (1)

This function prevents the speed of the motor from exceeding the predefined speed limit.

- 2 different speed limits can be defined and can be selected by logic inputs.
- If the motor speed exceeds the predefined speed limit value, safety function STO is triggered.

Once the SMS function is configured, it is continuously active.

Guard Door Locking (GDL) safety function (1)

This function allows you to release the guard door lock after specified delay when the motor power is turned off. The specified delay is chosen according to the type of stop.

The front door of the machine can be opened only after the motor is stopped; this function helps to ensure the safety of the machine operator.

Setting up the integrated safety functions (1)

Setting up the integrated safety functions in the Altivar Machine ATV320 drive does not require any options or additional accessories.

The functions are connected directly to the drive's digital inputs and can only be configured using SoMove setup software.

For more information, please refer to the SoMove catalog available on our website www.schneider-electric.com.

(1) Please refer to the "Altivar Machine ATV320 Safety Functions Manual" available on our website www.schneider-electric.com.

(2) Please refer to our web site <http://www.schneider-electric.com/machinesafety>.



ATV320U02M2C...U07M2C



ATV320U11M2C...U22M2C
ATV320U04N4C...U15N4C



ATV320U02M2B...U07M2B
ATV320U04N4B...U15N4B



ATV320U11M2B...U22M2B
ATV320U22N4B...U40N4B



CANopen communication module
with RJ45 connectors



CANopen communication module
with SUB-D connector



CANopen communication module
with connection via terminals

The offer

The Altivar Machine ATV320 range of variable speed drives covers motor power ratings from 0.18 kW/ 0.25 HP to 15 kW/20 HP with 4 types of power supply in book and compact control block design:

- 200 V...240 V single-phase, 0.18 kW/0.25 HP to 2.2 kW/3 HP (**ATV320U●●M2B**, **ATV320U●●M2C**)
- 200 V...240 V three-phase, 0.18 kW/0.25 HP to 15 kW/20 HP (**ATV320●●●M3C**)
- 380 V...500 V three-phase, 0.37 kW/0.50 HP to 15 kW/20 HP (**ATV320U●●N4C** and **ATV320●●●N4B**)
- 525 V...600 V three-phase, 0.75 kW/1 HP to 15 kW/20 HP (**ATV320●●●S6C**)

References ending with "B" indicate that the product has a book control block. The book control block product has a book format up to 4 kW/5 HP (book format is no longer available for 5.5/7 HP to 15 kW/20 HP). References ending with "C" designate that the product has a compact control block and a compact format. For the book format, several drives can be mounted side-by-side to save space.

Altivar Machine ATV320 drives integrate the Modbus and CANopen communication protocols as standard. Both can be accessed via the RJ45 connector on the front of the drive.

To simplify connection of the Altivar Machine ATV320 drive to the CANopen machine bus, 3 dedicated communication modules are available with different connectors:

- CANopen Daisy Chain module with 2 RJ45 connectors
- CANopen module with 9-way SUB-D connector
- CANopen module with 5-way terminal block

See pages 34 and 35.

In addition to the Modbus and CANopen standard protocols, Altivar Machine ATV320 drives can be connected to the main industrial communication buses and networks by adding one of the following optional communication modules:

- Modbus/TCP - Ethernet/IP
- PROFIBUS DP V1
- DeviceNet
- EtherCAT
- POWERLINK
- ProfiNet

See page 32.

Electromagnetic compatibility (EMC)

The built-in EMC filters in **ATV320U●●M2B**, **ATV320U●●M2C**, **ATV320●●●N4B**, and **ATV320U●●N4C** drives and compliance with EMC requirements simplify installation and provide an economical way for the device to meet the CE mark criteria.

The EMC filter enables compliance with standard IEC 61800-3:

- category C2 for a maximum motor cable length of:
 - 10 m/32.80 ft for **ATV320U●●M2B/ATV320U●●M2C** variable speed drives
 - 5 m/16.40 ft for **ATV320U04N4●...U40N4●** variable speed drives
- category C3 for a maximum motor cable length of:
 - 25 m/82.02 ft for **ATV320U55N4B...D15N4B** variable speed drives.

This filter can be disconnected via a jumper.

ATV320●●●M3C and **ATV320●●●S6C** variable speed drives do not have an integrated EMC filter. An additional EMC filter is required to enable compliance with standard IEC 61800-3, category C2.

Additional filters are available as an option and can be installed by the customer to reduce the level of emissions from Altivar Machine ATV320 variable speed drives. In particular, they allow a maximum motor cable length of 100 m/328.08 ft.

See page 28.

Accessories and external options

Accessories and external options are available with Altivar Machine ATV320 drives. The type of external accessories and options depends on the drive rating.

Accessories

- UL Type 1 conformity kits, plates for direct mounting on 35 mm/1.38 in. rails, etc.
- Bracket for direct mounting of GV2/ATV320U●●●●B circuit breaker
- Adapter for mounting the control module at 90°, for mounting the power module on its side, keeping the control module visible and accessible
- Daisy chain DC bus cordsets for daisy chain connection of the DC bus

See page 14.

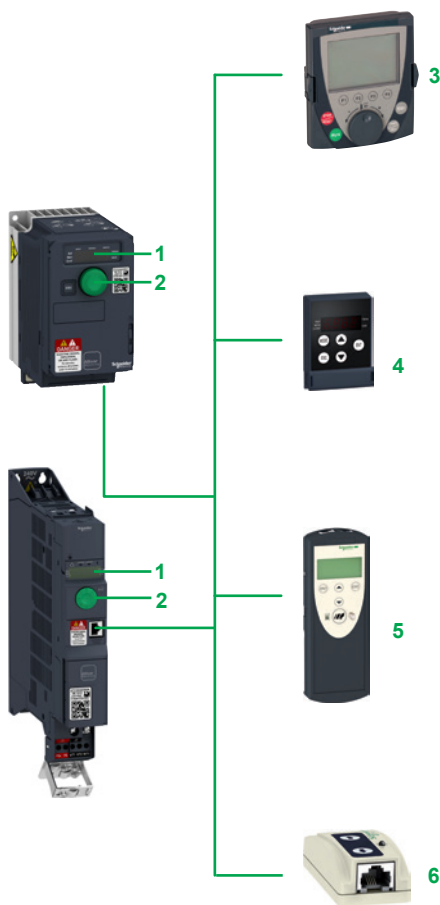

ATV320 dialog and configuration tools

The offer (continued)

External options

- Braking resistors
 - Line chokes
 - Motor chokes
 - Additional EMC filters
 - Adapter extension module for compact control block drive
 - Speed monitoring module
- See pages 24 to 31.

Dialog and configuration tools

Human-Machine interface

The 4-digit display **1** shows drive states, error codes, and parameter values. The navigation button **2** is used to navigate through the menus, modify values, and change the motor speed in local mode.

HMI terminals

Altivar Machine ATV320 drives can be connected to a graphic display terminal **3** or a remote display terminal **4**, which are available as options.

The HMI terminals can be mounted on an enclosure door with IP65 degree of protection. They provide the same level of access as the on-board Human-Machine interface.

The HMI terminal display in the majority of user languages, and provide a user-friendly environment for configuration, debugging or maintenance.

For more information, please see pages 16 to 17.

SoMove setup software

SoMove setup software is used to configure, adjust, debug (using the Oscilloscope function), and maintain Altivar Machine ATV320 drives in the same way as for other Schneider Electric drives and starters. See page 16.

For more information, please refer to the SoMove catalog available on our website www.schneider-electric.com.

Simple Loader and Multi-Loader configuration tools

The Simple Loader tool **6** enables the configuration from one powered-up drive to be duplicated on another powered-up drive.

The Multi-Loader tool **5** enables configurations from a PC or drive to be copied and duplicated on another drive; the drives do not need to be powered up.

See page 17.

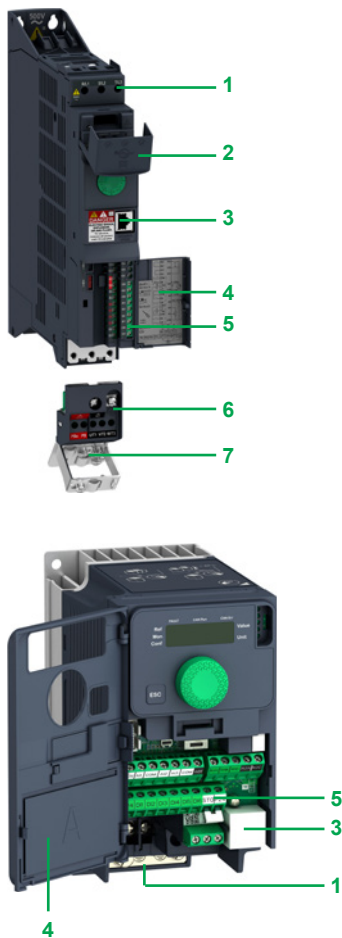

Description

- 1 Power terminals
 - 2 Protective cover to block access to the power terminals 1 when closed
 - 3 RJ45 communication port for access to integrated protocols: Modbus serial link and CANopen machine bus
 - 4 Protective cover for access to the control terminals (also includes a label with a wiring diagram)
 - 5 Control terminals for I/O connection:
 - 6 digital inputs:
 - 4 configurable for positive digital input (Sink) or negative digital input (Source)
 - 1 input configurable as a PTC probe input
 - 1 x 20 kHz pulse control input, 24 V $\overline{\text{---}}$, impedance 3.5 k Ω , sampling time 8 ms
 - 1 digital output:
 - 24 V $\overline{\text{---}}$, sampling time 2 ms, maximum voltage 30 V, maximum current 100 mA
 - 3 analog inputs:
 - 1 current analog input, by programming X and Y from 0 to 20 mA, impedance 250 Ω
 - 1 bipolar differential analog input ± 10 V, impedance 30 k Ω
 - 1 voltage analog input ± 10 V, impedance 30 k Ω , sampling time 2 ms
 - 1 analog output configurable as:
 - voltage analog output 0...10 V $\overline{\text{---}}$, minimum load impedance 470 Ω
 - current analog output 0...20 mA, maximum load impedance 800 Ω
 - 2 relay outputs:
 - 1 NC contact and 1 NO contact with common point
- Minimum switching capacity 5 mA for 24 V $\overline{\text{---}}$, maximum switching capacity 3 A on resistive load, 2 A on inductive load for 250 V \sim or 30 V $\overline{\text{---}}$
- 1 NC contact, maximum switching capacity 5 A on resistive load
 - 6 Removable motor power terminal block (allows quick disconnect and re-connect of motor cables during maintenance operations)
 - 7 EMC mounting plate (integral part of the motor power terminal block 6). This plate is supplied with a cable guide support, which can be used if required.

Standards and certifications (1)

Altivar Machine ATV320 drives have been developed to conform to the strictest international standards and recommendations relating to industrial electrical control devices (IEC), in particular:

- IEC 61800-5-1
- IEC 61800-3:
 - EMC immunity: IEC 61800-3, Environments 1 and 2
 - Conducted emission compliance:
 - IEC 61800-3, category C2, with integrated EMC filter for **ATV320...M2**, **ATV320U04N4...U40N4** drives
 - IEC 61800-3, category C2, with additional EMC filter for **ATV320...M3C** drives
 - IEC 61800-3, category C3, with integrated EMC filter for **ATV320U55N4B...D15N4B** drives
- ISO/EN 13849-1/-2 category 3 (PL d)
- IEC 61508 (parts 1 & 2)
- IEC 60721-3-3 classes 3C3 and 3S2

Altivar Machine ATV320 drives are certified:

- UL 508C / UL61800-5-1
- CSA 22.2 N274
- NOM
- EAC
- RCM

They are CE marked according to the European low voltage (2014/35/UE) and EMC (2014/30/UE) directives.

They also comply with environmental directives (RoHS).

(1) A complete list of certifications and characteristics is available on our website www.schneider-electric.com.

Variable speed drives

Altivar Machine ATV320

Drives with compact control block



ATV320U02M2C...U07M2C



ATV320U11M2C...U22M2C
ATV320U04N4C...U15N4C



ATV320U22N4C...
ATV320U40N4C



ATV320U55M3C



ATV320U07S6C



ATV320U15S6C

Drives with compact control block

Motor		Line supply				Altivar Machine ATV320					Reference (1)	Weight
Power indicated on rating plate (1)	Max. line current (2) (3)	Apparent power		Max. prospective line Isc (4)	Max. continuous output current (In) (1)	Max. transient current for 60s	Power dissipated at maximum output current (In) (1)	Reference (1)	Weight			
		at U1	at U2							at U2	kg/lb	
kW	HP	A	A	kVA	kA	A	A					
Single-phase supply voltage: 200...240 V 50/60 Hz, with integrated EMC filter (3) (5) (6)												
0.18	0.25	3.4	2.8	0.7	1	1.5	2.3	21.7		ATV320U02M2C	0.800/1.278	
0.37	0.5	5.9	4.9	1.2	1	3.3	5	32.2		ATV320U04M2C	1.000/2.204	
0.55	0.75	7.9	6.6	1.6	1	3.7	5.6	41.7		ATV320U06M2C	1.100/2.425	
0.75	1	10	8.4	2	1	4.8	7.2	48.3		ATV320U07M2C		
1.1	1.5	13.8	11.6	2.8	1	6.9	10.4	65.6		ATV320U11M2C	1.600/3.527	
1.5	2	17.8	14.9	3.6	1	8	12	82.4		ATV320U15M2C		
2.2	3	24	20.2	4.8	1	11	16.5	109.6		ATV320U22M2C		
Three-phase supply voltage: 200...240 V 50/60 Hz, without integrated EMC filter (3)												
0.18	0.25	2	1.7	0.7	5	1.5	2.3	21		ATV320U02M3C	0.800/1.278	
0.37	0.5	3.6	3	1.2	5	3.3	5	34		ATV320U04M3C	0.900/1.984	
0.55	0.75	4.9	4.2	1.7	5	3.7	5.6	40		ATV320U06M3C	1.000/2.204	
0.75	1	6.3	5.3	2.2	5	4.8	7.2	49		ATV320U07M3C		
1.1	1.5	8.6	7.2	3	5	6.9	10.4	66		ATV320U11M3C	1.400/3.086	
1.5	2	11.1	9.3	3.9	5	8	12	69		ATV320U15M3C		
2.2	3	14.9	12.5	5.2	5	11	16.5	92		ATV320U22M3C		
3	4	19	15.9	6.6	5	13.7	20.6	109		ATV320U30M3C	2.200/4.850	
4	5	23.8	19.9	8.3	5	17.5	26.3	141		ATV320U40M3C		
5.5	7.5	35.4	29.8	12.4	22	27.5	41.3	261		ATV320U55M3C	3.500/7.716	
7.5	10	45.3	38.2	15.9	22	33	49.5	324		ATV320U75M3C	3.600/7.937	
11	15	60.9	51.4	21.4	22	54	81	528		ATV320D11M3C	6.800/14.991	
15	20	79.7	67.1	27.9	22	66	99	545		ATV320D15M3C	6.900/15.212	
Three-phase supply voltage: 380...500 V 50/60 Hz, with integrated EMC filter (3) (5) (6)												
0.37	0.5	2.1	1.6	1.4	5	1.5	2.3	28		ATV320U04N4C	1.200/2.646	
0.55	0.75	2.8	2.2	1.9	5	1.9	2.9	33		ATV320U06N4C		
0.75	1	3.6	2.8	2.4	5	2.3	3.5	38		ATV320U07N4C		
1.1	1.5	5	3.8	3.3	5	3	4.5	47		ATV320U11N4C	1.300/2.866	
1.5	2	6.4	4.9	4.2	5	4.1	6.2	61		ATV320U15N4C		
2.2	3	8.7	6.6	5.7	5	5.5	8.3	76		ATV320U22N4C	2.100/4.630	
3	4	11.1	8.4	7.3	5	7.1	10.7	94		ATV320U30N4C		
4	5	13.7	10.6	9.2	5	9.5	14.3	112		ATV320U40N4C	2.200/4.850	
Three-phase supply voltage: 525...600 V 50/60 Hz, without integrated EMC filter (3) (7)												
0.75	1	1.5	1.4	1.5	5	1.7	2.6	31		ATV320U07S6C	1.300/2.866	
1.5	2	2.6	2.4	2.5	5	2.7	4.1	40		ATV320U15S6C		
2.2	3	3.7	3.2	3.4	5	3.9	5.9	50		ATV320U22S6C	2.000/4.409	
4	5	6.5	5.8	6.0	5	6.1	9.2	72		ATV320U40S6C	2.500/5.511	
5.5	7.5	8.4	7.5	7.8	22	9.0	13.5	114		ATV320U55S6C	3.500/7.716	
7.5	10	11.6	10.5	10.9	22	11.0	16.5	136		ATV320U75S6C		
11	15	15.8	14.1	14.7	22	17.0	25.5	197		ATV320D11S6C	6.500/14.330	
15	20	22.1	20.1	20.9	22	22.0	33.0	228		ATV320D15S6C		

(1) These values are given for a nominal switching frequency of 4 kHz, for use in continuous operation. The switching frequency is adjustable from 2 to 16 kHz. Above 4 kHz, derate the nominal drive current. The nominal motor current should not exceed this value (see derating curves).
 (2) Typical value for a 4-pole motor and a maximum switching frequency of 4 kHz, with no line choke for max. prospective line Isc (4).
 (3) Nominal supply voltage, min. U1, max. U2: 200 (U1)...240 V (U2), 380 (U1)...500 V (U2).
 (4) If line Isc is greater than the values in the table, add line chokes.
 (5) Drives supplied with category C2 integrated EMC filter. This filter can be disconnected.
 (6) Drives are supplied with an EMC plate, for assembly by the customer.
 (7) A line choke is mandatory with ATV320●●●S6C drives. To be ordered separately, see page 26.

ATV320U02M2B...U07M2B
ATV320U04N4B...U15N4BATV320U11M2B...U22M2B
ATV320U22N4B...U40N4B

ATV320U55N4B



ATV320D15N4B

Drives with book control block

Motor		Line supply				Altivar Machine ATV320				Reference (1)	Weight
Power indicated on rating plate (1)	Max. line current (2),(3)	Apparent power		Max. prospective line Isc (4)	Max. continuous output current (In) (1)	Max. transient current for 60s	Power dissipated at maximum output current (In) (1)	kg/ lb			
		at U1	at U2						at U2	A	A
kW	HP	A	A	kVA	kA	A	A				
Single-phase supply voltage: 200...240 V 50/60 Hz, with integrated EMC filter (3) (5) (6)											
0.18	0.25	3.4	2.8	0.7	1	1.5	2.3	25	ATV320U02M2B	2.400/ 5.291	
0.37	0.5	6	5	1.2	1	3.3	5	38	ATV320U04M2B	2.500/ 5.511	
0.55	0.75	7.9	6.7	1.6	1	3.7	5.6	42	ATV320U06M2B		
0.75	1	10.1	8.5	2	1	4.8	7.2	51	ATV320U07M2B	2.400/ 5.291	
1.1	1.5	13.6	11.5	2.8	1	6.9	10.4	64	ATV320U11M2B	2.900/ 6.393	
1.5	2	17.6	14.8	3.6	1	8	12	81	ATV320U15M2B		
2.2	3	23.9	20.1	4.8	1	11	16.5	102	ATV320U22M2B		
Three-phase supply voltage: 380...500 V 50/60 Hz, with integrated EMC filter (3) (5) (6)											
0.37	0.5	2.1	1.6	1.4	5	1.5	2.3	27	ATV320U04N4B	2.500/ 5.511	
0.55	0.75	2.8	2.2	1.9	5	1.9	2.9	31	ATV320U06N4B	2.600/ 5.732	
0.75	1	3.6	2.7	2.3	5	2.3	3.5	37	ATV320U07N4B		
1.1	1.5	5	3.8	3.3	5	3	4.5	50	ATV320U11N4B	2.500/ 5.511	
1.5	2	6.5	4.9	4.2	5	4.1	6.2	63	ATV320U15N4B		
2.2	3	8.7	6.6	5.7	5	5.5	8.3	78	ATV320U22N4B	3.000/ 6.614	
3	4	11.1	8.4	7.3	5	7.1	10.7	100	ATV320U30N4B		
4	5	13.7	10.5	9.1	5	9.5	14.3	125	ATV320U40N4B		
5.5	7.5	20.7	14.5	12.6	22	14.3	21.5	233	ATV320U55N4B	7.500/ 16.534	
7.5	10	26.5	18.7	16.2	22	17	25.5	263	ATV320U75N4B		
11	15	36.6	25.6	22.2	22	27.7	41.6	403	ATV320D11N4B	8.700/ 19.180	
15	20	47.3	33.3	28.8	22	33	49.5	480	ATV320D15N4B	8.800/ 19.401	

(1) These values are given for a nominal switching frequency of 4 kHz, for use in continuous operation. The switching frequency is adjustable from 2 to 16 kHz. Above 4 kHz, derate the nominal drive current. The nominal motor current should not exceed this value (see derating curves).

(2) Typical value for a 4-pole motor and a maximum switching frequency of 4 kHz, with no line choke for max. prospective line Isc (4).

(3) Nominal supply voltage, min. U1, max. U2: 200 (U1)...240 V (U2), 380 (U1)...500 V (U2), 525 (U1)...600 V (U2).

(4) If line Isc is greater than the values in the table, add line chokes.

(5) Drives supplied with category C2 integrated EMC filter. This filter can be disconnected.

(6) Connection in compliance with EMC standards:

- ATV320●●●M2B, ATV320U04N4B...ATV320U40N4B drives are supplied with an EMC plate. This is integral part of the power terminal; these 2 components cannot be separated.

- ATV320U55N4B...D15N4B drives are supplied with an EMC plate, for assembly by the customer.

Accessories				
Description	For use with	Minimum order quantity	Reference	Weight kg/lb
Components for mounting GV2 circuit breaker directly on ATV320 drive				
Bracket for GV2/ATV320 direct mounting Mechanical bracket for holding the GV2 circuit breaker in place when directly mounted on the ATV320 drive. Requires a GV2AF5 adapter plate for electrical connection, to be ordered separately	ATV320●●●M2B ATV320U04N4B...U40N4B	10	VW3A9921	0.075/ 0.165
Adapter plate Provides the electrical link between the GV2 circuit breaker and the ATV320 drive when the GV2 is directly mounted on the ATV320. Requires a VW3A9921 bracket for direct mounting, to be ordered separately.	ATV320●●●M2B ATV320U02N4B...U40N4B	10	GV2AF5	0.016/ 0.035
Mounting the control module at 90°				
Adapter for mounting the control module at 90° This is used to mount the power module on the side, keeping the control module visible and accessible.	ATV320●●●M2B ATV320U04N4B...U40N4B		VW3A9920	0.125/ 0.276

Daisy chain connection of the DC bus (1)

The DC bus is connected in a daisy chain in the following cases:

- Drives powered by the AC supply with parallel connection of the DC bus in order to balance the loads during braking phases between the drives; used in addition to braking resistors (see page 24)
- Drives powered by the DC bus only

Requires the connection accessories listed below:

Description	Use		Length m/ft	Sold in lots of	Unit Reference	Weight kg/lb
	From	To				
Cordset (1) equipped with 2 connectors	ATV320●●●●M2B ATV320●●●●N4B	ATV320●●●●M2B ATV320●●●●N4B	0.1/ 0.33	5	VW3M7101R01	–
Shielded cable	ATV320●●●●M2B ATV320●●●●N4B	ATV320●●●●M2B ATV320●●●●N4B	15/ 49.21	1	VW3M7102R150	–
Connection kit for VW3M7102R150 cable	–	–	–	10	VW3M2207	–

Shielding connection clamp				
Description	For use with	Sold in lots of	Unit Reference	Weight kg/lb
Shielding connection clamps Attachment and earthing of the cable shielding Pack of 25 clamps including: ■ 20 clamps for Ø 4.8 mm (0.19 in.) cable ■ 5 clamps for Ø 7.9 mm (0.31 in.) cable	ATV320●●●●●●●●	25	TM200RSRCCEMC	–

DIN rail mounting kit				
Description	For use with	Reference	Weight kg/lb	
Plates for mounting on DIN rail width 35 mm (1.38 in.)	ATV320U02M●C...ATV320U07M●C ATV320U11M●C...ATV320U22M●C, ATV320U04N4C...ATV320U15N4C, ATV320U07S6C, ATV320U15S6C	VW3A9804 VW3A9805	0.290/ 0.639 0.385/ 0.849	

(1) Setting up several devices on the DC bus requires special precautions; please refer to the installation manual available on our website www.schneider-electric.com.



Accessories (continued)

UL Type 1 conformity kits

Description	For use with	Reference	Weight kg/ lb
UL Type 1 conformity kits Mechanical device for attaching to the lower part of the drive. For direct connection of cables to the drive via tubes or cable glands.	ATV320U02M●C...U07M●C	VW3A95811	0.370/ 0.816
	ATV320U11M2C...U22M2C, ATV320U04N4C...U15N4C, ATV320U07S6C, ATV320U15S6C	VW3A95812	0.440/ 0.970
	ATV320U11M3C...U22M3C	VW3A95813	0.480/ 1.058
	ATV320U22N4C...U40N4C, ATV320U22S6C, ATV320U40S6C	VW3A95814	0.550/ 1.213
	ATV320U30M3C...U40M3C	VW3A95815	0.580/ 1.279
	ATV320U55M3C...U75M3C, ATV320U55S6C, ATV320U75S6C	VW3A95816	0.820/ 1.808
	ATV320U55N4B, ATV320U75N4B	VW3A95817	1.410/ 3.109
	ATV320D11M3C...D15M3C, ATV320D11S6C, ATV320D15S6C	VW3A95818	1.160/ 2.557
	ATV320D11N4B, ATV320D15N4B	VW3A95819	1.680/ 3.704

Mounting accessories

Description	For drives	Reference	Weight kg/ lb
EMC conformity kits These provide a connection compliant with EMC standards (for further information, please consult our website www.schneider-electric.com .) The kit consists of: ■ The EMC plate ■ Clamps ■ Fixing accessories	ATV320U02M3C, ATV320U04M3C, ATV320U06M3C, ATV320U07M3C	VW3A9523	0.170/ 0.374
	ATV320U11M3C, ATV320U15M3C, ATV320U22M3C, ATV320U07S6C, ATV320U15S6C	VW3A9524	0.190/ 0.418
	ATV320U30M3C, ATV320U40M3C, ATV320U22S6C, ATV320U40S6C	VW3A9525	0.210/ 0.462
	ATV320U55M3C, ATV320U75M3C, ATV320U55S6C, ATV320U75S6C	VW3A9532	0.200/ 0.440
	ATV320D11M3C, ATV320D15M3C, ATV320D11S6C, ATV320D15S6C	VW3A9533	0.260/ 0.573

Replacement parts

Description	For use with	Reference	Weight kg/ lb
Fans			
Fan for variable speed drive	ATV320U11M3C...U40M3C	VZ3V1302	–
	ATV320U11M2C...U22M2C, ATV320U04N4C...U15N4C, ATV320U07S6C, ATV320U15S6C	VZ3V303S2001	–
	ATV320U22N4C...U40N4C, ATV320U22S6C, ATV320U40S6C	VZ3V303S3001	–
	ATV320U02M2B...U07M2B, ATV320U04N4B...U15N4B	VZ3V32A100	–
	ATV320U11M2B...U22M2B, ATV320U22N4B...U40N4B	VZ3V32B100	–
	ATV320U55M3C, ATV320U75M3C, ATV320U55N4B, ATV320U75N4B, ATV320U55S6C, ATV320U75S6C, ATV320D11S6C	VZ3V32C100	–
	ATV320D11M3C, ATV320D15M3C, ATV320D11N4B, ATV320D15N4B, ATV320D15S6C	VZ3V32D100	–
Other			
Removable motor power terminal block	ATV320U02M2B...U40N4B	VY1F32AB1001	–
Pluggable fan connector	ATV320U02M2B...D15N4B	VY1F10007V21	–
I/O control card	ATV320●●●●●C	VW3A36201	0.200/ 0.440

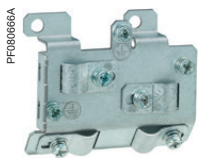

VW3A9523



VW3A9524



VW3A9532

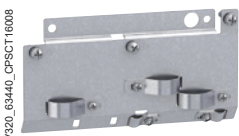

VW3A9533

Variable speed drives

Altivar Machine ATV320

Option: configuration tools

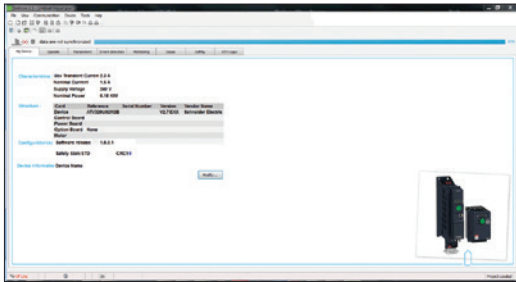

Altivar Machine DTM in SoMove software

DTM

Presentation

Using FDT/DTM technology it is possible to configure, control, and diagnose Altivar Machine drives directly in SoMachine and SoMove software by means of the same software brick (DTM).

FDT/DTM technology standardizes the communication interface between field devices and host systems. The DTM contains a uniform structure for managing drive access parameters.

The Altivar Machine ATV320 DTM library is a flexible, open, and interactive tool that can be used in a third-party FDT.

DTMs can be downloaded from our website www.schneider-electric.com.

Specific functions of the Altivar Machine ATV320 DTM

- Offline or online access to drive data
- Transfer of configuration files from and to the drive
- Customization (My Menu)
- Access to drive parameters and option cards
- Oscilloscope function
- Graphic interface to assist with configuration of the Altivar Machine ATV320
- Drive parameter monitoring
- Detected error and warning logs

Advantages of the DTM library in SoMachine

SoMachine software is a single tool for configuration, setup, and diagnostics for the complete machine. It can be integrated in the fieldbus topology.

SoMachine additionally offers Function Block library possibilities for Altivar Machine drives.

Advantages of the DTM library in SoMove

SoMove is a drive-oriented software environment.

It allows a wired connection directly to the drive Modbus serial port.

SoMove setup software

SoMove Lite setup software for PC is used to prepare drive configuration files.

The USB/RJ45 cable (reference TCSCMCNAM3M002P) connects to the USB port of the PC running software and to the RJ45 port on the device.

For more information, refer to the SoMove catalog available on our website www.schneider-electric.com.



VW3A8121



VW3A8120



Configuring an Altivar 320 in its packaging:
VW3A8121 + VW3A8126 cordset

Simple Loader and Multi-Loader configuration tools

The Simple Loader tool enables one drive configuration to be duplicated and transferred to another drive (both drives must be powered up). It is connected to the drive RJ45 communication port.

The Multi-Loader tool enables a number of configurations from a PC or drive to be copied and loaded onto other drives (Altivar Machine ATV320 drives do not need to be powered up when using the Multi-Loader tool).

References

Description	Reference	Weight kg/lb
Simple Loader configuration tool Supplied with a cordset equipped with 2 RJ45 connectors	ATV320●●●● VW3A8120	—
Multi-Loader configuration tool Supplied with: <ul style="list-style-type: none"> - 1 cordset equipped with 2 RJ45 connectors - 1 cordset equipped with one type A USB connector and one mini B USB connector - 1 SD memory card - 1 female/female RJ45 adapter - 4 AA/LR6 1.5 V batteries - 1 anti-shock protector - 1 carrying handle 	ATV320●●●● VW3A8121	—
Cordset for Multi-Loader tool For connecting the Multi-Loader tool to the Altivar 320 drive in its packaging. Equipped with a non-locking RJ45 connector with special mechanical catch on the drive end and an RJ45 connector on the Multi-Loader end.s	ATV320●●●● in its packaging VW3A8126	—
USB/RJ45 cable equipped with a USB connector and an RJ45 connector. For connecting a PC to the Altivar Machine ATV320. Length: 2.5 m (8.20 ft.)	ATV320●●●● TCSMCNAM3M002P	—



Remote display terminal with cover open



Remote display terminal with cover closed

Remote display terminal

This terminal is used to locate the Human-Machine Interface of the Altivar Machine ATV320 drive remotely on the door of an enclosure with IP 54 or IP 65 protection. It is used to:

- Control, adjust, and configure the drive remotely
- Display the drive status and error codes

Its maximum operating temperature is 50 °C/122 °F.

Description

- 1 4-digit display
- 2 Navigation ▲, ▼ and selection ENT, ESC keys
- 3 Motor local control keys:
 - RUN: Starts the motor
 - FWD/REV: Reverses the direction of rotation of the motor
 - STOP/RESET: Stops the motor/clears detected errors
- 4 MODE: Operating mode selection key
- 5 Cover for access to the motor local control keys

References

Description	Degree of protection	Length	Reference	Weight
				kg/lb
Remote display terminals	IP 54	–	VW3A1006	0.250/ 0.551
A remote-mounting cordset, VW3A1104R●●, is also required	IP 65	–	VW3A1007	0.275/ 0.606
Remote-mounting cordsets equipped with 2 RJ45 connectors	–	1.0/ 3.28	VW3A1104R10	0.050/ 0.110
	–	3.0/ 9.84	VW3A1104R30	0.150/ 0.331



Remote graphic display terminal



Portable use of the remote graphic display terminal: 1 + 2 + 3



Using the remote graphic display terminal on enclosure door: 1 + 2 + 4 (+ 5, if IP 65)

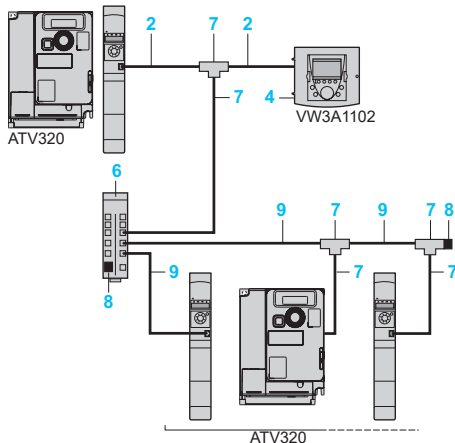

Example of connection via multidrop link

Remote graphic display terminal

This remote graphic display terminal, common across Schneider Electric's variable speed drive ranges, provides a user-friendly interface for configuration, debugging, and maintenance. In particular, it is possible to transfer and store up to 4 configurations. For portable use or mounted on an enclosure door, it can also be connected to multiple drives (see page 18).

Its main functions are as follows:

- The graphic screen displays 8 lines of 24 characters of plain text.
- The navigation button provides quick and easy access to the drop-down menus.
- It is supplied with 6 languages installed (Chinese, English, French, German, Italian, and Spanish). The available languages can be modified using the Multi-Loader configuration tool (VW3A8121).

Its maximum operating temperature is 60 °C/140 °F, and it features IP 54 protection; this can be increased to IP 65 when mounted on an enclosure door.

Description

- 1 Graphic display: 8 lines of 24 characters, 240 x 160 pixels, large digit display
- 2 Function keys (not operational on the Altivar 320)
- 3 **Navigation button:**
 - Rotate ±: Goes to the next/previous line, increases/decreases the value
 - Press: Saves the current value (**ENT**)
 - **ESC** key: Aborts a value, parameter, or menu to return to the previous selection
- 4 Motor local control keys:
 - **RUN**: Starts the motor
 - **STOP/RESET**: Stops the motor/clears detected errors
 - **FWD/REV**: Reverses the direction of rotation of the motor

References

Item no.	Description	Length m/ft	Reference	Weight kg/lb
1	Remote graphic display terminal A remote-mounting cordset, VW3A1104R●●●, and an RJ45 adapter, VW3A1105, are required	–	VW3A1101	0.180/0.396
2	Remote-mounting cordsets equipped with 2 RJ45 connectors Remote operation of the ATV320 and the remote graphic display terminal VW3A1101	1.0/3.28	VW3A1104R10	0.050/0.110
		3.0/9.84	VW3A1104R30	0.150/0.331
		5.0/16.40	VW3A1104R50	0.250/0.551
		10/32.81	VW3A1104R100	0.500/1.102
3	Female/female RJ45 adapter	–	VW3A1105	0.010/0.022
4	Remote mounting kit For mounting on enclosure door IP 54 degree of protection	–	VW3A1102	0.150/0.331
5	Door Used to increase the degree of protection for remote mounting kit VW3A1102 to IP 65 To be mounted on remote mounting kit VW3A1102	–	VW3A1103	0.040/0.088

Additional accessories for multidrop connection

Item no.	Description	Unit reference	Weight kg/lb	
6	Modbus splitter box: 10 RJ45 connectors and 1 screw terminal block	LU9GC3	0.500/1.102	
7	Modbus T-junction boxes With integrated cable (0.3 m/0.98 ft)	VW3A8306TF03	–	
		VW3A8306TF10	–	
8	Modbus line terminator For RJ45 connector R = 120 Ω, C = 1 nf	VW3A8306RC	0.010/0.022	
		sold by lots of 2		
Item no.	Description	Length m/ft	Reference	Weight kg/lb
9	Cordsets for Modbus serial link equipped with 2 RJ45 connectors	0.3/0.98	VW3A8306R03	0.025/0.055
		1/3.28	VW3A8306R10	0.060/0.132
		3/9.84	VW3A8306R30	0.130/0.287

Example of connection via multidrop link

All the components described on this page enable a remote graphic display terminal to be connected to several drives via a multidrop link. This multidrop link is connected to the RJ45 port on the Modbus/CANopen communication port. See the example opposite.

Variable speed drives

Altivar Machine ATV320

Combinations of options for Altivar 320 drives

Combinations of options for Altivar 320 drives																
Motor		Drive	Accessories					Options								
			Bracket for GV2 direct mounting	DC bus connector kit	DIN rail kit	UL Type 1 conformity kits	Shielding connection clamps	Braking resistors			Line chokes	Motor chokes	Additional EMC filters	Communication adapter card		
kW	HP									IP20	IP65 - 0.75 m/ 29.53 in. cable	IP65 - 3 m/ 118.11 in. cable				
Drive with compact control block - single-phase supply voltage: 200...240 V 50/60 Hz																
0.18	0.25	ATV320U02M2C	–	–	VW3A9804	VW3A95811	TM200RSRCEMC			VW3A7730	VW3A7608R07	VW3A7608R30	–	VW3A4552	VW3A31401	VW3A3600
0.37	0.5	ATV320U04M2C	–	–	VW3A9804	VW3A95811	TM200RSRCEMC			VW3A7730	VW3A7608R07	VW3A7608R30	–	VW3A4552	VW3A31401	VW3A3600
0.55	0.75	ATV320U06M2C	–	–	VW3A9804	VW3A95811	TM200RSRCEMC			VW3A7731	VW3A7608R07	VW3A7608R30	VZ1L007UM50	VW3A4552	VW3A31401	VW3A3600
0.75	1	ATV320U07M2C	–	–	VW3A9804	VW3A95811	TM200RSRCEMC			VW3A7731	VW3A7608R07	VW3A7608R30	VZ1L007UM50	VW3A4552	VW3A31401	VW3A3600
1.1	1.5	ATV320U11M2C	–	–	VW3A9805	VW3A95812	TM200RSRCEMC			VW3A7731	VW3A7605R07	VW3A7605R30	VZ1L018UM20	VW3A4552	VW3A31403	VW3A3600
1.5	2	ATV320U15M2C	–	–	VW3A9805	VW3A95812	TM200RSRCEMC			VW3A7731	VW3A7605R07	VW3A7605R30	VZ1L018UM20	VW3A4552	VW3A31403	VW3A3600
2.2	3	ATV320U22M2C	–	–	VW3A9805	VW3A95812	TM200RSRCEMC			VW3A7732	VW3A7603R07	VW3A7603R30	VZ1L018UM20	VW3A4553	VW3A31405	VW3A3600
Drive with compact control block - three-phase supply voltage: 200...240 V 50/60 Hz																
0.18	0.25	ATV320U02M3C	–	–	VW3A9804	VW3A95811	TM200RSRCEMC			VW3A7730	VW3A7608R07	VW3A7608R30	VW3A4551	VW3A4552	VW3A31402	VW3A3600
0.37	0.5	ATV320U04M3C	–	–	VW3A9804	VW3A95811	TM200RSRCEMC			VW3A7730	VW3A7608R07	VW3A7608R30	VW3A4551	VW3A4552	VW3A31402	VW3A3600
0.55	0.75	ATV320U06M3C	–	–	VW3A9804	VW3A95811	TM200RSRCEMC			VW3A7731	VW3A7608R07	VW3A7608R30	VW3A4551	VW3A4552	VW3A31402	VW3A3600
0.75	1	ATV320U07M3C	–	–	VW3A9804	VW3A95811	TM200RSRCEMC			VW3A7731	VW3A7608R07	VW3A7608R30	VW3A4551	VW3A4552	VW3A31402	VW3A3600
1.1	1.5	ATV320U11M3C	–	–	VW3A9805	VW3A95813	TM200RSRCEMC			VW3A7731	VW3A7605R07	VW3A7605R30	VW3A4552	VW3A4552	VW3A31404	VW3A3600
1.5	2	ATV320U15M3C	–	–	VW3A9805	VW3A95813	TM200RSRCEMC			VW3A7731	VW3A7605R07	VW3A7605R30	VW3A4552	VW3A4552	VW3A31404	VW3A3600
2.2	3	ATV320U22M3C	–	–	VW3A9805	VW3A95813	TM200RSRCEMC			VW3A7732	VW3A7603R07	VW3A7603R30	VW3A4553	VW3A4553	VW3A31404	VW3A3600
3	4	ATV320U30M3C	–	–	–	VW3A95815	TM200RSRCEMC			VW3A7732	VW3A7604R07	VW3A7604R30	VW3A4553	VW3A4553	VW3A31406	VW3A3600
4	5	ATV320U40M3C	–	–	–	VW3A95815	TM200RSRCEMC			VW3A7733	VW3A7604R07	VW3A7604R30	VW3A4554	VW3A4554	VW3A31406	VW3A3600
5.5	7.5	ATV320U55M3C	–	–	–	VW3A95816	TM200RSRCEMC			VW3A7733	–	–	VW3A4554	VW3A4554	VW3A31407	VW3A3600
7.5	10	ATV320U75M3C	–	–	–	VW3A95816	TM200RSRCEMC			VW3A7734	–	–	VW3A4554	VW3A4554	VW3A31407	VW3A3600
11	15	ATV320D11M3C	–	–	–	VW3A95818	TM200RSRCEMC			VW3A7735	–	–	VW3A4555	VW3A4556	VW3A31408	VW3A3600
15	20	ATV320D15M3C	–	–	–	VW3A95818	TM200RSRCEMC			VW3A7736 (IP23)	–	–	VW3A4555	VW3A4556	VW3A31408	VW3A3600
Drive with compact control block - three-phase supply voltage: 380...500 V 50/60 Hz																
0.37	0.5	ATV320U04N4C	–	–	VW3A9804	VW3A95812	TM200RSRCEMC			VW3A7730	VW3A7608R07	VW3A7608R30	VW3A4551	VW3A4552	VW3A31404	VW3A3600
0.55	0.75	ATV320U06N4C	–	–	VW3A9804	VW3A95812	TM200RSRCEMC			VW3A7730	VW3A7608R07	VW3A7608R30	VW3A4551	VW3A4552	VW3A31404	VW3A3600
0.75	1	ATV320U07N4C	–	–	VW3A9804	VW3A95812	TM200RSRCEMC			VW3A7730	VW3A7608R07	VW3A7608R30	VW3A4551	VW3A4552	VW3A31404	VW3A3600
1.1	1.5	ATV320U11N4C	–	–	VW3A9804	VW3A95812	TM200RSRCEMC			VW3A7730	VW3A7608R07	VW3A7608R30	VW3A4551	VW3A4552	VW3A31404	VW3A3600
1.5	2	ATV320U15N4C	–	–	VW3A9805	VW3A95812	TM200RSRCEMC			VW3A7730	VW3A7608R07	VW3A7608R30	VW3A4551	VW3A4552	VW3A31404	VW3A3600
2.2	3	ATV320U22N4C	–	–	VW3A9805	VW3A95814	TM200RSRCEMC			VW3A7730	VW3A7608R07	VW3A7608R30	VW3A4552	VW3A4552	VW3A31406	VW3A3600
3	4	ATV320U30N4C	–	–	VW3A9805	VW3A95814	TM200RSRCEMC			VW3A7730	VW3A7606R07	VW3A7606R30	VW3A4552	VW3A4552	VW3A31406	VW3A3600
4	5	ATV320U40N4C	–	–	VW3A9805	VW3A95814	TM200RSRCEMC			VW3A7731	VW3A7606R07	VW3A7606R30	VW3A4552	VW3A4552	VW3A31406	VW3A3600
Drive with compact control block - three-phase supply voltage: 525...600 V (kW) 50/60 Hz																
0.75	1	ATV320U07S6C	–	–	VW3A9805	VW3A95812	TM200RSRCEMC			VW3A7730	VW3A7608R07	VW3A7608R30	VW3A4551	VW3A4552	–	VW3A3600
1.5	2	ATV320U15S6C	–	–	VW3A9805	VW3A95812	TM200RSRCEMC			VW3A7730	VW3A7608R07	VW3A7608R30	VW3A4551	VW3A4552	–	VW3A3600
2.2	3	ATV320U22S6C	–	–	–	VW3A95814	TM200RSRCEMC			VW3A7730	VW3A7608R07	VW3A7608R30	VW3A4551	VW3A4552	–	VW3A3600
4	5	ATV320U40S6C	–	–	–	VW3A95814	TM200RSRCEMC			VW3A7730	VW3A7606R07	VW3A7606R30	VW3A4552	VW3A4552	–	VW3A3600
5.5	7.5	ATV320U55S6C	–	–	–	VW3A95816	TM200RSRCEMC			VW3A7731	VW3A7604R07	VW3A7604R30	VW3A4553	VW3A4552	–	VW3A3600
7.5	10	ATV320U75S6C	–	–	–	VW3A95816	TM200RSRCEMC			VW3A7732	VW3A7604R07	VW3A7604R30	VW3A4553	VW3A4553	–	VW3A3600
11	15	ATV320D11S6C	–	–	–	VW3A95818	TM200RSRCEMC			VW3A7732	–	–	VW3A4554	VW3A4554	–	VW3A3600
15	20	ATV320D15S6C	–	–	–	VW3A95818	TM200RSRCEMC			VW3A7732	–	–	VW3A4554	VW3A4554	–	VW3A3600

Variable speed drives

Altivar Machine ATV320

Combinations of options for Altivar 320 drives

Option modules for ATV320 drives

Combinations of options for Altivar 320 drives														
Motor		Drive	Accessories					Options						
kW	HP		Bracket for GV2 direct mounting	DC bus connector kit	DIN rail kit	UL Type 1 conformity kits	Shielding connection clamps	Braking resistors			Line chokes	Motor chokes	Additional EMC filters	Communication adapter card
							IP20	IP65 - 0.75 m/ 29.53 in. cable	IP65 - 3 m/ 118.11 in. cable					
Drive with book control block - single-phase supply voltage: 200...240 V 50/60 Hz														
0.18	0.25	ATV320U02M2B	VW3A9921	VW3M2207	-	-	TM200RSRCEMC	VW3A7730	VW3A7608R07	VW3A7608R30	-	VW3A4552	VW3A4420	-
0.37	0.5	ATV320U04M2B	VW3A9921	VW3M2207	-	-	TM200RSRCEMC	VW3A7730	VW3A7608R07	VW3A7608R30	-	VW3A4552	VW3A4420	-
0.55	0.75	ATV320U06M2B	VW3A9921	VW3M2207	-	-	TM200RSRCEMC	VW3A7731	VW3A7608R07	VW3A7608R30	VZ1L007UM50	VW3A4552	VW3A4420	-
0.75	1	ATV320U07M2B	VW3A9921	VW3M2207	-	-	TM200RSRCEMC	VW3A7731	VW3A7608R07	VW3A7608R30	VZ1L007UM50	VW3A4552	VW3A4420	-
1.1	1.5	ATV320U11M2B	VW3A9921	VW3M2207	-	-	TM200RSRCEMC	VW3A7731	VW3A7605R07	VW3A7605R30	VZ1L018UM20	VW3A4552	VW3A4421	-
1.5	2	ATV320U15M2B	VW3A9921	VW3M2207	-	-	TM200RSRCEMC	VW3A7731	VW3A7605R07	VW3A7605R30	VZ1L018UM20	VW3A4552	VW3A4421	-
2.2	3	ATV320U22M2B	VW3A9921	VW3M2207	-	-	TM200RSRCEMC	VW3A7732	VW3A7603R07	VW3A7603R30	VZ1L018UM20	VW3A4553	VW3A4426	-
Drive with book control block - three-phase supply voltage: 380...500 V 50/60 Hz														
0.37	0.5	ATV320U04N4B	VW3A9921	VW3M2207	-	-	TM200RSRCEMC	VW3A7730	VW3A7608R07	VW3A7608R30	VW3A4551	VW3A4552	VW3A4422	-
0.55	0.75	ATV320U06N4B	VW3A9921	VW3M2207	-	-	TM200RSRCEMC	VW3A7730	VW3A7608R07	VW3A7608R30	VW3A4551	VW3A4552	VW3A4422	-
0.75	1	ATV320U07N4B	VW3A9921	VW3M2207	-	-	TM200RSRCEMC	VW3A7730	VW3A7608R07	VW3A7608R30	VW3A4551	VW3A4552	VW3A4422	-
1.1	1.5	ATV320U11N4B	VW3A9921	VW3M2207	-	-	TM200RSRCEMC	VW3A7730	VW3A7608R07	VW3A7608R30	VW3A4551	VW3A4552	VW3A4422	-
1.5	2	ATV320U15N4B	VW3A9921	VW3M2207	-	-	TM200RSRCEMC	VW3A7730	VW3A7608R07	VW3A7608R30	VW3A4551	VW3A4552	VW3A4422	-
2.2	3	ATV320U22N4B	VW3A9921	VW3M2207	-	-	TM200RSRCEMC	VW3A7730	VW3A7608R07	VW3A7608R30	VW3A4552	VW3A4552	VW3A4422	-
3	4	ATV320U30N4B	VW3A9921	VW3M2207	-	-	TM200RSRCEMC	VW3A7730	VW3A7606R07	VW3A7606R30	VW3A4552	VW3A4552	VW3A4422	-
4	5	ATV320U40N4B	VW3A9921	VW3M2207	-	-	TM200RSRCEMC	VW3A7731	VW3A7606R07	VW3A7606R30	VW3A4552	VW3A4552	VW3A4422	-
5.5	7.5	ATV320U55N4B	-	-	-	VW3A95817	TM200RSRCEMC	VW3A7731	VW3A7604R07	VW3A7604R30	VW3A4553	VW3A4553	VW3A4424	-
7.5	10	ATV320U75N4B	-	-	-	VW3A95817	TM200RSRCEMC	VW3A7732	VW3A7604R07	VW3A7604R30	VW3A4553	VW3A4554	VW3A4424	-
11	15	ATV320D11N4B	-	-	-	VW3A95819	TM200RSRCEMC	VW3A7732	-	-	VW3A4554	VW3A4554	VW3A4425	-
15	20	ATV320D15N4B	-	-	-	VW3A95819	TM200RSRCEMC	VW3A7733	-	-	VW3A4554	VW3A4555	VW3A4425	-

Option modules (1) (2)		
Description	Reference	Page
Communication option modules		
CANopen Daisy Chain 2 x RJ45 communication module	VW3A3608	34
CANopen SUB-D9 communication module	VW3A3618	34
CANopen open style communication module	VW3A3628	35
Ethernet TCP/IP communication module	VW3A3616	36
EtherCAT 2 x RJ45 communication module	VW3A3601	37
Profibus DP communication module	VW3A3607	37
DeviceNet communication module	VW3A3609	37
POWERLINK communication module	VW3A3619	37
ProfiNet communication module	VW3A3627	37
Other option modules		
Speed monitoring card - RS422 - 5V	VW3A3620	31

(1) To use with ATV320 drives with a compact control block, the option module adapter is required (to be ordered separately).

(2) Only one module can be connected at once.

PF106005

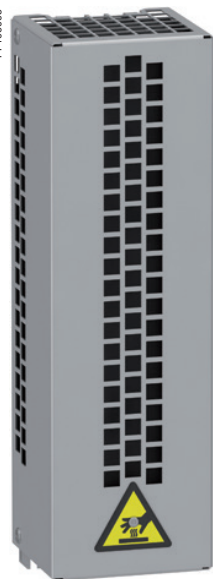

VW3A7731

Presentation

Braking resistors allow Altivar Machine ATV320 drives to operate while braking to a standstill or during slowdown braking, by dissipating the braking energy. They enable maximum transient braking torque.

Depending on the drive rating, the following types of resistor are available:

- Enclosed model (IP 20 casing) designed to comply with the EMC standard and protected by a temperature-controlled switch
- Enclosed model (IP 65 casing) with cordset

Note: To optimize the size of the braking resistor, the DC buses on Altivar Machine ATV320 drives in the same application can be connected in parallel (see page 14).

Applications

Machines with high inertia, driving loads, and machines with fast cycles.

References

For drives	Ohmic value	Average power available at 50 °C/122 °F (1)	Length of connection cable	Reference	Weight
	Ω	W	m/ft		kg/lb
IP 20 resistors					
ATV320U02M●●, ATV320U04M●●, ATV320U04N4●...U30N4●, ATV320U07S6C...U40S6C	100	100	–	VW3A7730	1.500/3.307
ATV320U06M●●...U15M●●, ATV320U40N4C, ATV320U40N4B, ATV320U55N4B, ATV320U55S6C	60	160	–	VW3A7731	1.800/3.968
ATV320U22M●●, ATV320U30M3C, ATV320U75N4B, ATV320D11N4B, ATV320U75S6C, ATV320D11S6C, ATV320D15S6C	28	300	–	VW3A7732	2.700/5.952
ATV320U40M3C, ATV320U55M3C, ATV320D15N4B	16	960	–	VW3A7733	3.800/8.377
ATV320U75M3C	10	960	–	VW3A7734	4.300/9.480
ATV320D11M3C	8	960	–	VW3A7735	18.000/39.683
ATV320D15M3C	5	1900	–	VW3A7736	1.500/3.307

(1) Load factor for resistors: the value of the average power that can be dissipated at 50 °C/122 °F from the resistor into the casing is determined for a load factor during braking that corresponds to the majority of normal applications:

- 2 s braking with a 0.6 T_n braking torque for a 40 s cycle
- 0.8 s braking with a 1.5 T_n braking torque for a 40 s cycle



VW3A7608R●●

References (continued)					
For drives	Ohmic value	Average power available at 50 °C/122 °F (1)	Length of connection cable	Reference	Weight
	Ω	W	m/ft		kg/lb
IP 65 resistors					
ATV320U02M2C...U07M2C, ATV320U02M2B...U07M2B, ATV320U04N4C, ATV320U22N4C, ATV320U04N4B, ATV320U22N4B, ATV320U07S6C, ATV320U15S6C, ATV320U22S6C, ATV320U40S6C	100	25	0.75/ 2.46	VW3A7608R07	0.410/0.904
			3.0/ 9.84	VW3A7608R30	0.760/1.675
ATV320U30N4C, ATV320U40N4C, ATV320U30N4B, ATV320U40N4B	72	50	0.75/ 2.46	VW3A7606R07	0.930/2.050
			3.0/ 9.84	VW3A7606R30	1.200/2.645
ATV320U11M2C, ATV320U15M2C, ATV320U11M2B, ATV320U15M2B	72	25	0.75/ 2.46	VW3A7605R07	0.620/1.367
			3.0/ 9.84	VW3A7605R30	0.850/1.874
ATV320U55N4B, ATV320U75N4B	27	100	0.75/ 2.46	VW3A7604R07	1.420/3.131
			3.0/ 9.84	VW3A7604R30	1.620/3.571
ATV320U22M2C, ATV320U22M2B	27	50	0.75/ 2.46	VW3A7603R07	0.930/2.050
			3.0/ 9.84	VW3A7603R30	1.200/2.645

(1) Load factor for resistors: the value of the average power that can be dissipated at 50 °C/122 °F from the resistor into the casing is determined for a load factor during braking that corresponds to the majority of normal applications:- 2 s braking with a 0.6 T_n braking torque for a 40 s cycle- 0.8 s braking with a 1.5 T_n braking torque for a 40 s cycle.

Nota: no optional IP65 braking resistors for ATV320U55S6C, ATV320U75S6C, ATV320D11S6C, ATV320D15S6C, and ATV320●●M3C drives.

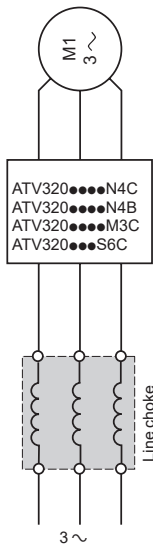
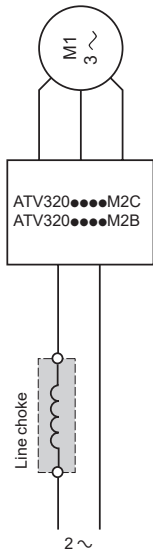

Presentation

Line chokes

Line chokes, also known as line reactors, provide improved immunity against overvoltages on the supply mains and can reduce harmonic distortion of the current produced by the drive.

The recommended chokes limit the line current. They have been developed in line with standard IEC 61800-5-1 (VDE 0160 level 1 high-energy overvoltages on the line supply).

The inductance values are defined for a voltage drop between 3% and 5% of the nominal line voltage. Values higher than this will cause loss of torque.

The use of line chokes is recommended in particular under the following circumstances:

- Supply mains with significant disturbance from other equipment (interference, overvoltages)
 - Supply mains with voltage imbalance between phases > 1.8% of nominal voltage
 - Drive supplied by a supply mains with very low impedance (in the vicinity of a power transformer 10 times more powerful than the drive rating)
 - Installation of a large number of frequency inverters on the same supply mains
 - Reduction of overloads on the $\cos \varphi$ correction capacitors, if the installation includes a power factor correction unit
- The prospective short-circuit current at the point of connection of the drive must not exceed the maximum value indicated in the reference tables (see page 12). The use of chokes allows connection to the following supply mains:
- Max. Isc 22 kA for 200/240 V
 - Max. Isc 65 kA for 380/500 V

References

Drive Reference	Line current, without choke		Line current, with choke		Choke Reference	Weight kg/lb
	U min. (1) A	U max. (1) A	U min. (1) A	U max. (1) A		
Single-phase supply voltage: 200...240 V 50/60 Hz						
ATV320U06M2C, ATV320U06M2B	6.8	5.8	5.2	4.3	VZ1L007UM50	0.880/1.940
ATV320U07M2C, ATV320U07M2B	8.9	7.5	7.0	5.9		
ATV320U11M2C, ATV320U11M2B	12.1	10.2	10.2	8.6	VZ1L018UM20	1.990/4.387
ATV320U15M2C, ATV320U15M2B	15.8	13.3	13.4	11.4		
ATV320U22M2C, ATV320U22M2B	21.9	18.4	19.2	16.1		
Three-phase supply voltage: 200...240 V 50/60 Hz						
ATV320U02M3C	2.0	1.7	1.0	0.8	VW3A4551	1.500/3.307
ATV320U04M3C	3.6	3.0	1.8	1.6		
ATV320U06M3C	4.9	4.2	2.7	2.2		
ATV320U07M3C	6.3	5.3	3.5	2.9		
ATV320U11M3C	8.6	7.2	5.0	4.2	VW3A4552	3.000/6.613
ATV320U15M3C	11.1	9.3	6.6	5.5		
ATV320U22M3C	14.9	12.5	9.3	7.9	VW3A4553	3.500/7.716
ATV320U30M3C	19.0	15.9	12.4	10.4		
ATV320U40M3C	23.8	19.9	16.2	13.7	VW3A4554	6.000/13.228
ATV320U55M3C	35.4	29.8	21.6	18.1		
ATV320U75M3C	45.3	38.2	28.8	24.0		
ATV320D11M3C	60.9	51.4	40.9	34.4	VW3A4555	11.000/24.251
ATV320D15M3C	79.7	67.1	54.4	45.4		
Three-phase supply voltage: 380...500 V 50/60 Hz						
ATV320U04N4C, ATV320U04N4B	2.2	1.7	1.1	0.9	VW3A4551	1.500/3.307
ATV320U06N4C, ATV320U06N4B	2.8	2.2	1.4	1.2		
ATV320U07N4C, ATV320U07N4B	3.6	2.7	1.8	1.5		
ATV320U11N4C, ATV320U11N4B	4.9	3.7	2.6	2		
ATV320U15N4C, ATV320U15N4B	6.4	4.8	3.4	2.6		
ATV320U22N4C, ATV320U22N4B	8.9	6.7	5	4.1	VW3A4552	3.000/6.613
ATV320U30N4C, ATV320U30N4B	10.9	8.3	6.5	5.2		
ATV320U40N4C, ATV320U40N4B	13.9	10.6	8.5	6.6		
ATV320U55N4B	21.9	16.5	11.7	9.3	VW3A4553	3.500/7.716
ATV320U75N4B	27.7	21	15.4	12.1		
ATV320D11N4B	37.2	28.4	22.5	18.1	VW3A4554	6.000/13.228
ATV320D15N4B	48.2	36.8	29.6	23.3		
Three-phase supply voltage: 525...600 V 50/60 Hz (2)						
ATV320U07S6C	–	–	1.5	1.4	VW3A4551	1.500/3.307
ATV320U15S6C	–	–	2.6	2.4		
ATV320U22S6C	–	–	3.7	3.2		
ATV320U40S6C	–	–	6.5	5.8	VW3A4552	3.000/6.613
ATV320U55S6C	–	–	8.4	7.5	VW3A4553	3.500/7.716
ATV320U75S6C	–	–	11.6	10.5		
ATV320D11S6C	–	–	15.8	14.1	VW3A4554	6.000/13.228
ATV320D15S6C	–	–	22.1	20.1		

(1) Nominal supply voltage

(2) ATV320●●●S6C drives must not be used without a Line choke

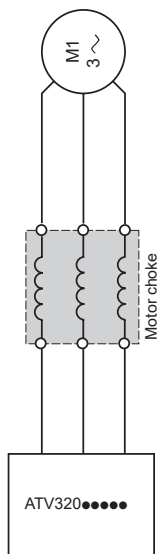

Presentation

Motor chokes

Motor chokes, also known as load reactors, can be inserted between the Altivar Machine ATV320 drive and the motor to:

- Limit the dv/dt at the motor terminals (500 to 1500 V/μs), for cables longer than 50 m/164.04 ft
- Filter interference caused by the opening of a contactor placed between the filter and the motor
- Reduce the motor ground leakage current
- Smooth the motor current wave form to reduce motor noise

References

For drives	Losses W	Cable length (1)		Nominal current A	Reference	Weight kg/lb
		Shielded cable m/ft	Unshielded cable m/ft			
Single-phase supply voltage: 200...240 V 50/60 Hz						
ATV320U02M2C...U15M2C ATV320U02M2B...U15M2B	65	≤ 100/328.08	≤ 200/656.17	10	VW3A4552	3.000/6.613
ATV320U22M2C, ATV320U22M2B	75	≤ 100/328.08	≤ 200/656.17	16	VW3A4553	3.500/7.716
Three-phase supply voltage: 200...240 V 50/60 Hz						
ATV320U02M3C...U15M3C	65	≤ 100/328.08	≤ 200/656.17	10	VW3A4552	3.000/6.613
ATV320U22M3C, ATV320U30M3C	75	≤ 100/328.08	≤ 200/656.17	16	VW3A4553	3.500/7.716
ATV320U40M3C...U75M3C	90	≤ 100/328.08	≤ 200/656.17	30	VW3A4554	6.000/13.228
ATV320D11M3C...D15M3C	260	≤ 100/328.08	≤ 200/656.17	107	VW3A4556	16.000/35.274
Three-phase supply voltage: 380...500 V 50/60 Hz						
ATV320U04N4C...U40N4C ATV320U04N4B...U40N4B	65	≤ 100/328.08	≤ 200/656.17	10	VW3A4552	3.000/6.613
ATV320U55N4B	75	≤ 100/328.08	≤ 200/656.17	16	VW3A4553	3.500/7.716
ATV320U75N4B, ATV320D11N4B	90	≤ 100/328.08	≤ 200/656.17	30	VW3A4554	6.000/13.228
ATV320D15N4B	80	≤ 100/328.08	≤ 200/656.17	60	VW3A4555	11.000/24.251
Three-phase supply voltage: 525...600 V 50/60 Hz						
ATV320U07S6C, ATV320U15S6C, ATV320U22S6C, ATV320U40S6C, ATV320U55S6C	65	≤ 100/328.08	≤ 200/656.17	10	VW3A4552	3.000/6.613
ATV320U75S6C	75	≤ 100/328.08	≤ 200/656.17	16	VW3A4553	3.500/7.716
ATV320D11S6C, ATV320D15S6C	75	≤ 100/328.08	≤ 200/656.17	16	VW3A4554	6.000/13.228

(1) For an application with several motors connected in parallel, the total motor cable lengths must be added together. If a cable longer than that recommended is used, the filters may overheat.

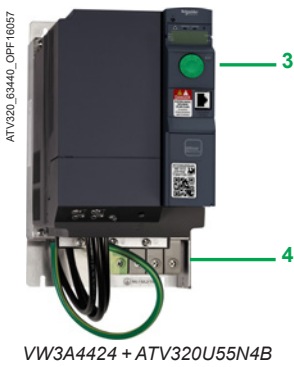
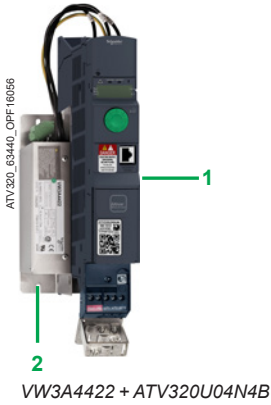

Presentation

Additional EMC input filters

The additional EMC input filters enable the drives to meet more stringent requirements; they are designed to reduce conducted emissions on the supply mains below the limits of standard IEC 61800-3 category C1 or C2 (see below).

Mounting on ATV320●●●●B

- Depending on the model, additional EMC filters can be mounted beside or underneath the drive.
- They act as a support for the drives and are attached to them via tapped holes.

Mounting the filter on the side of the drive:

- 1 ATV320●●●M2B, ATV320U04N4B...U40N4B drives
- 2 Additional EMC input filters

Mounting the filter underneath the drive:

- 3 ATV320U55N4B...U75N4B and ATV320D11N4B...D15N4B drives
- 4 Additional EMC input filters

Mounting on ATV320●●●●C

Additional EMC filters can be mounted beside or underneath the ATV320●●●●C drives, except for the ATV320●●●S6C drives.

They act as a support for the drives and are attached to them via tapped holes.

Use according to the type of supply mains

- Additional EMC filters can only be used on TN (neutral connection) and TT (grounded neutral) type systems.
- Standard IEC 61800-3, appendix D2.1, states that on IT systems (isolated or impedance grounded neutral), filters can cause permanent insulation monitors to operate in a random manner.
- The effectiveness of additional filters on this type of system depends on the type of impedance between neutral and ground, and therefore cannot be predicted.
- If a machine has to be installed on an IT system, one solution is to insert an isolation transformer and connect the machine locally on a TN or TT system.
- The radio interference input filters integrated in Altivar 320 drives can easily be disconnected by means of a selector switch without removing the drive.

References							
Additional EMC input filters							
For drives	Additional EMC input filter						
Reference	Maximum length of shielded cable (1) (2)		In (3)	Losses (4)	Mounting the filter/ Book format	Reference	Weight
	IEC 61800-3 (5)						
	Category C2	Category C1	A	W	kg/lb		
Single-phase supply voltage: 200...240 V 50/60 Hz							
ATV320U02M2C...U07M2C	50/ 164.04	20/ 65.61	9	3.7	–	VW3A31401	0.600/ 1.323
ATV320U11M2C...U15M2C	50/ 164.04	20/ 65.61	16	6.9	–	VW3A31403	0.775/ 1.709
ATV320U22M2C	50/ 164.04	20/ 65.61	22	7.5	–	VW3A31405	1.130/ 2.491
ATV320U02M2B...U07M2B	50/ 164.04	20/ 65.61	10.1	3.7	On the side	VW3A4420	0.600/ 1.323
ATV320U11M2B...U15M2B	50/ 164.04	20/ 65.61	17.6	6.9	On the side	VW3A4421	0.775/ 1.709
ATV320U22M2B	50/ 164.04	20/ 65.61	23.9	7.5	On the side	VW3A4426	1.130/ 2.491
Three-phase supply voltage: 200...240 V 50/60 Hz							
ATV320U02M3C...U07M3C	5/ 16.40	1/ 3.28	7	2.6	–	VW3A31402	0.650/ 1.433
ATV320U11M3C...U22M3C	5/ 16.40	1/ 3.28	15	9.9	–	VW3A31404	1.000/ 2.205
ATV320U30M3C...U40M3C	5/ 16.40	1/ 3.28	25	15.8	–	VW3A31406	1.650/ 3.637
ATV320U55M3C...U75M3C	5/ 16.40	1/ 3.28	47	19.3	–	VW3A31407	3.150/ 6.945
ATV320D11M3C...D15M3C	5/ 16.40	1/ 3.28	83	35.2	–	VW3A31408	5.300/ 11.684
Three-phase supply voltage: 380...500 V 50/60 Hz							
ATV320U04N4C...U15N4C	50/ 164.04	20/ 65.61	15	9.9	–	VW3A31404	1.000/ 2.205
ATV320U22N4C...U40N4C	50/ 164.04	20/ 65.61	25	15.8	–	VW3A31406	1.650/ 3.637
ATV320U04N4B...U40N4B	50/ 164.04	20/ 65.61	15	9.9	On the side	VW3A4422	0.900/ 1.984
ATV320U55N4B...U75N4B	50/ 164.04	20/ 65.61	47	19.3	Underneath	VW3A4424	3.150/ 6.944
ATV320D11N4B...D15N4B	50/ 164.04	20/ 65.61	49	27.4	Underneath	VW3A4425	4.750/ 10.472

(1) The filter selection tables give the maximum lengths for shielded cables connecting motors to drives. These maximum lengths are given as examples only, as they vary depending on the stray capacitance of the motors and the cables used. If motors are connected in parallel, it is the total length of all cables that should be taken into account.

(2) These values are given for a nominal switching frequency of 4 kHz.

(3) In: nominal filter current.

(4) Via heat dissipation, at the nominal filter current (In).

(5) Standard IEC 61800-3: EMC immunity and conducted and radiated EMC emissions:

- Category C1: public power supply (residential)
- Category C2: industrial power supply

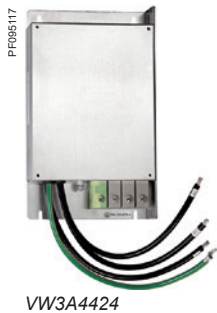



Example of installing a communication module 3
(view of underside) on a drive with compact control block

Presentation

Altivar Machine ATV320 drives are designed for use with option modules according to machine and application requirements; only one option module can be used with an Altivar Machine ATV320 at a time.

The option modules are compatible with all Altivar Machine ATV320 drives (see page 20).

The **VW3A3600** option module adapter is required to connect an option module to Altivar Machine ATV320 drives with a compact control block.

Compact control block

An adapter should be added to the Altivar Machine ATV320 drives with compact control block in order to connect communication and speed monitoring modules.

- 1 Communication adapter card
- 2 Slot for the communication or speed monitoring module
- 3 Communication module

References

Description	Reference	Weight kg/lb
Communication adapter card for ATV320 with compact control block	VW3A3600	–

Book control block

Altivar Machine ATV320 drives with a book control block have been designed to simplify connections to communication buses and networks by means of the following:

- 4 Integrated RJ45 communication port for Modbus/CANopen on the front
- 5 Slot for the communication module
- 6 Communication module

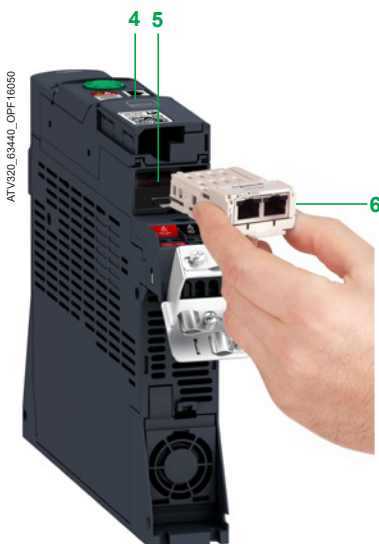

Example of installing a communication module 6
(view of underside) on a drive with book control block

PF130614



VW3A3620

Presentation

The **VW3A3620** speed monitoring module is recommended for hoisting applications.

This module helps to detect undesired load slip on hoisting applications by means of an external encoder. The variable speed drive manages the load slip according to the configuration parameters.

Functions

- The load slip frequency threshold represents the difference between the speed feedback and the output frequency.
- The load slip detection level can be adjusted so that the function can be used more efficiently.
- The load slip direction check allows the variable speed drive to check that movement is initiated in the desired direction.
- The load slip detection duration can be configured in order to optimize the use of the function according to the changing mechanics.

The **VW3A3620** speed monitoring module helps to ensure that the actual motor speed is within the acceptable threshold settings and that movement is in the desired direction.

The variable speed drive will trigger a warning and the motor will stop either with a freewheel stop or via the brake logic control function (depending on the configuration) in the following cases:

- if the actual speed is different from the permitted speed reference threshold and this reaches the defined duration, or
- if the direction of motor rotation is not as expected

Speed monitoring module (1)

Description	Reference	Weight kg/lb
Speed monitoring module	VW3A3620	0.300/ 0.660
Port: One 6-way screw connector		
■ RS422		
■ Input nominal voltage: 5 V		

(1) To use with ATV320 drives with a compact control block, the option module adapter is required (to be ordered separately).

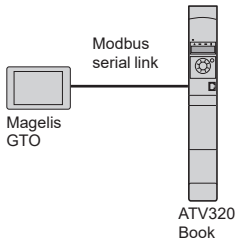

Example of configuration on Modbus serial link

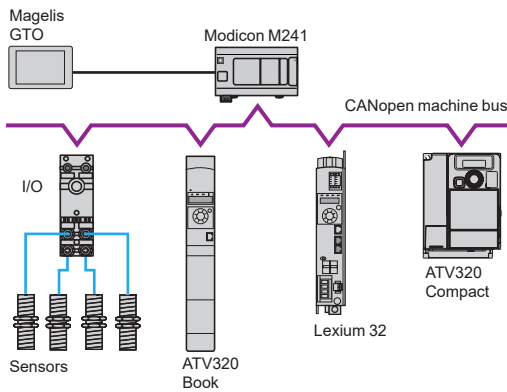

Example of configuration on CANopen machine bus

Presentation

Altivar Machine ATV320 drives are designed to meet the configuration requirements found in the main industrial communication installations.

The Modbus and CANopen communication protocols are integrated as standard and can be accessed directly via the RJ45 communication port located on the front of the book control block drive and underneath the front door of the compact control block drive.

ATV320 drives can also be connected to other industrial communication buses and networks by using one of the communication modules available as an option.

Communication modules are supplied in “cassette” format for ease of mounting/removal.

Modbus serial link (1)

The Modbus serial link is used for connecting the following HMI and configuration tools:

- The Magelis HMI terminal
- Remote display terminal, remote graphic display terminal
- SoMove setup software, Simple Loader and Multi-loader configuration tools

CANopen machine bus (1) (2) (3)

The CANopen machine bus is used for integration into control system architectures, especially when combined with Modicon M241 and M251 logic controllers or Lexium 32 motion controllers.

Optimized solutions for connection to the CANopen machine bus

To simplify setting up the Altivar Machine ATV320 drive, 3 dedicated CANopen communication modules (2) are available depending on the connection and connector types:

- CANopen daisy chain module with 2 RJ45 connectors offering an optimized solution for daisy chain connection to the CANopen machine bus (see page 34)
- CANopen module for connection to the bus via 9-way SUB-D connector (see page 34)
- CANopen module for connection to the bus via terminals (see page 35)

Using one of the CANopen communication modules also reduces the installation dimensions compared to using **VW3CANTAP2** and **TSXCANTDM4** junction boxes.

Communication modules for industrial applications (3)

The following communication modules are available:

- Modbus TCP and EtherNet/IP
- PROFIBUS DP V1
- DeviceNet
- EtherCAT
- POWERLINK
- ProfiNet

Description

Altivar Machine ATV320 drives with book control block have been designed to simplify connections to communication buses and networks by means of the following:

- 1 Integrated RJ45 communication port for Modbus/CANopen on the front
- 2 Slot for the communication module
- 3 Communication module

Altivar Machine ATV320 drives with compact control block are equipped as standard with:

- 1 Integrated RJ45 communication port for Modbus/CANopen
- The **VW3A3600** mechanical adapter for communication modules can be used to make more communication buses and networks available by inserting the corresponding module directly into the adapter.
- 2 Slot for the communication module
- 3 Communication module

(1) The Modbus serial link always uses the RJ45 communication port. If simultaneous use of the Modbus serial link and the CANopen machine bus is required, a CANopen communication module is needed.

(2) When one of the CANopen communication modules is inserted in the Altivar 320 drive, CANopen communication via the RJ45 communication port is disabled.

(3) The Altivar 320 drive can only take one communication module.

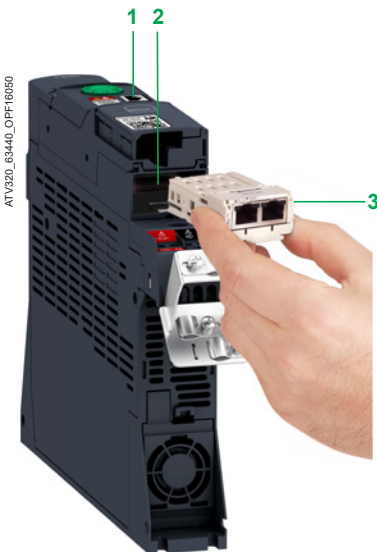

Example of installing a communication module 3 (view of underside)



Altivar 320 compact format drive with communication module in the option module adapter

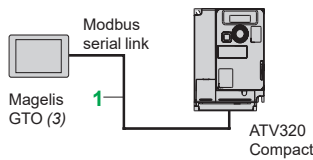

Example of connection of an Altivar 320 compact format drive and a Magelis GTO HMI terminal via the Modbus serial link

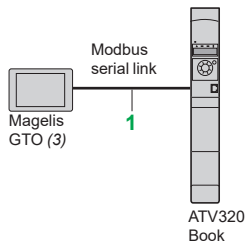

Example of connection of an Altivar 320 book format drive and a Magelis GTO HMI terminal via the Modbus serial link

Functions

All Altivar Machine ATV320 drive functions can be accessed via the communication buses and networks:

- Control
- Monitoring
- Adjustment
- Configuration

The speed reference and command may come from different sources:

- digital input or analog I/O terminals
- Communication bus or network
- Remote display terminals

The ATV320 drive's advanced functions can be used to manage switching of these drive control sources according to the application requirements.

The communication periodic I/O data assignment can be selected using the network configuration software.

The ATV320 drive can be controlled:

- According to the CiA 402 native profile
- According to the I/O profile

Communication is monitored according to criteria specific to each protocol.

Regardless of protocol type, the reaction of the drive to a detected communication interruption can be configured as follows:

- Freewheel stop, stop on ramp, fast stop, or braked stop
- Maintain the last command received
- Fallback position at a predefined speed
- Ignore the detected error

Modbus serial link (1)

Connection accessories for remote Human-Machine Interface (2)

Description	Item no.	Length m/ft	Reference	Weight kg/lb
Cordsets for Modbus serial link equipped with 2 RJ45 connectors	1	0.3/0.98	VW3A8306R03	0.025/ 0.055
		1.0/3.28	VW3A8306R10	0.060/ 0.132
		3.0/9.84	VW3A8306R30	0.130/ 0.287

(1) The Modbus serial link always uses the RJ45 communication port. If simultaneous use of the Modbus serial link and the CANopen machine bus is required, a CANopen communication module is needed.

(2) See page 18 for connection of a remote display terminal or remote graphic display terminal.

(3) Requires a 24 V $\bar{\text{V}}$ power supply. Please refer to the "Human/Machine interfaces" catalog.



VW3A3608

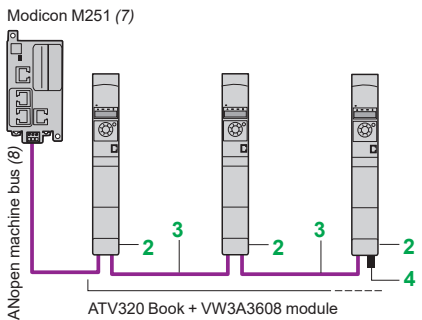
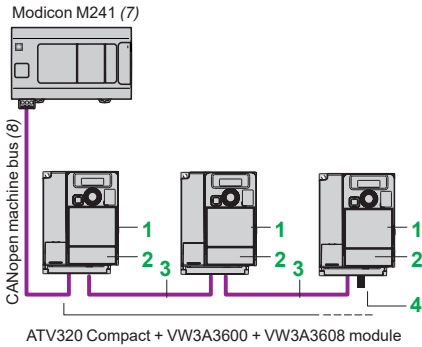

Optimized solution for daisy chain connection to the CANopen machine bus



VW3A3618

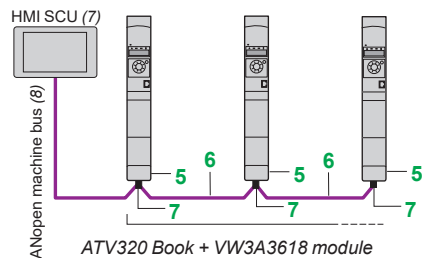

Example of connection to the CANopen machine bus via SUB-D connector

Compact drive communication adapter (1)

Description	Item no.	Length m/ft	Unit reference	Weight kg/lb
Communication module adapter for ATV320 Compact	1	–	VW3A3600	–

CANopen machine bus (2)

Description	Item no.	Length m/ft	Unit reference	Weight kg/lb
Connection with VW3A3608 CANopen daisy chain module (optimized solution for daisy chain connection to the CANopen machine bus)				

CANopen daisy chain communication module (2) (3) (4) Ports: 2 RJ45 connectors	2	–	VW3A3608	–
--	---	---	----------	---

CANopen cordsets equipped with 2 RJ45 connectors	3	0.3/0.98	VW3CANCARR03	0.050/0.110
		1.0/3.28	VW3CANCARR1	0.500/1.102

CANopen line terminator for RJ45 connector	4	–	TCSCAR013M120	–
--	---	---	---------------	---

Connection via SUB-D connector with VWA3618 CANopen module

CANopen communication module (2) (3) Port: 1 x 9-way male SUB-D connector	5	–	VW3A3618	–
--	---	---	----------	---

CANopen cable Standard cable, CE marking Low smoke zero halogen Flame retardant (IEC 60332-1)	6	50/164.04	TSXCANCA50	4.930/10.869
		100/328.08	TSXCANCA100	8.800/19.401
		300/984.25	TSXCANCA300	24.560/54.145

CANopen cable Standard cable, UL certification, CE marking Flame retardant (IEC 60332-2)	6	50/164.04	TSXCANCB50	3.580/7.892
		100/328.08	TSXCANCB100	7.840/17.284
		300/984.25	TSXCANCB300	21.870/48.215

CANopen cable Cable for harsh environments (5) or mobile installations, CE marking Low smoke zero halogen Flame retardant (IEC 60332-1)	6	50/164.04	TSXCANCD50	3.510/7.738
		100/328.08	TSXCANCD100	7.770/17.130
		300/984.25	TSXCANCD300	21.700/47.840

CANopen IP 20 straight connector 9-way female SUB-D with line terminator that can be deactivated	7	–	TSXCANKCDF180T	0.049/0.108
--	---	---	----------------	-------------

IP 20 CANopen right angle connector (6) 9-way female SUB-D with line terminator that can be deactivated	7	–	TSXCANKCDF90T	0.046/0.101
---	---	---	---------------	-------------

- (1) Altivar Machine ATV320 products with a compact control block require the VW3A3600 option module adapter in order to use any communication option modules.
- (2) The Modbus serial link always uses the RJ45 communication port. If simultaneous use of the Modbus serial link and the CANopen machine bus is required, a CANopen communication module is needed.
- (3) The Altivar Machine ATV320 drive can only take one communication module.
- (4) When one of the CANopen communication modules is inserted in the Altivar Machine ATV320 drive, CANopen communication via the RJ45 communication port on the front is disabled.
- (5) Standard environment:
 - No particular environmental constraints
 - Operating temperature between 5 and 60 °C/41 and 140 °F
 - Fixed installation
 Harsh environment:
 - Resistance to hydrocarbons, industrial oils, detergents, solder splashes
 - Relative humidity up to 100%
 - Saline atmosphere
 - Operating temperature between -10 and +70 °C/14 and 158 °F
 - Significant temperature variations
- (6) Incompatible with side-by-side mounting.
- (7) Please refer to the "Modicon M241 logic controller", "Modicon M251 logic controller", and "Magelis SCU small HMI controllers" catalogs.
- (8) Cable dependent on the type of controller or PLC; please refer to the corresponding catalog.

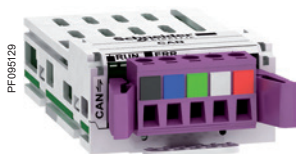

VW3A3628

Modicon M251 (4)

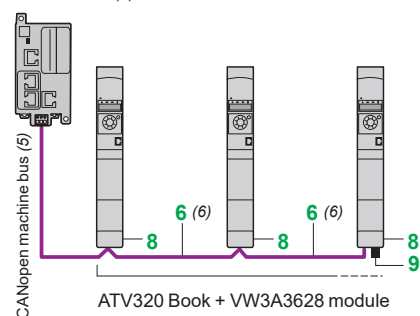

Example of connection to the CANopen machine bus via screw terminals

CANopen machine bus (continued) (1)(7)

Description	Item no.	Length m/ft	Unit reference	Weight kg/lb
-------------	----------	-------------	----------------	--------------

Connection via terminals with VW3A3628 CANopen module

CANopen communication module (2) (3) Port: 1 x 5-way screw terminal block	8	–	VW3A3628	–
--	----------	---	-----------------	---

CANopen line terminator for screw terminal connector	9	–	TCSCAR01NM120	–
--	----------	---	----------------------	---

Other connection accessories and cordsets

IP 20 CANopen cordsets equipped with 2 x 9-way female SUB-D connectors. Standard cable, CÉ marking Low smoke zero halogen Flame retardant (IEC 60332-1)	–	0.3/ 0.98	TSXCANCADD03	0.091/ 0.201
	–	1.0/ 3.28	TSXCANCADD1	0.143/ 0.315
	–	3.0/ 9.84	TSXCANCADD3	0.295/ 0.650
	–	5.0/ 16.40	TSXCANCADD5	0.440/ 0.970

IP 20 CANopen cordsets equipped with 2 x 9-way female SUB-D connectors. Standard cable, UL certification, CÉ marking Flame retardant (IEC 60332-2)	–	0.3/ 0.98	TSXCANCBDD03	0.086/ 0.190
	–	1.0/ 3.28	TSXCANCBDD1	0.131/ 0.289
	–	3.0/ 9.84	TSXCANCBDD3	0.268/ 0.591
	–	5.0/ 16.40	TSXCANCBDD5	0.400/ 0.882

IP 20 CANopen junction boxes equipped with: ■ 4 x 9-way male SUB-D connectors + screw terminal block for trunk cable tap link ■ Line terminator	–	–	TSXCANTDM4	0.196/ 0.432
---	---	---	-------------------	-----------------

IP 20 CANopen junction boxes equipped with: ■ 2 screw terminal blocks for trunk cable tap link ■ 2 RJ45 connectors for connecting drives ■ 1 RJ45 connector for connecting a PC	–	–	VW3CANTAP2	0.480/ 1.058
--	---	---	-------------------	-----------------

(1) The Modbus serial link always uses the RJ45 communication port. If simultaneous use of the Modbus serial link and the CANopen machine bus is required, a CANopen communication module is needed.

(2) The Altivar Machine ATV320 drive can only take one communication module.

(3) When one of the CANopen communication modules is inserted in the Altivar Machine ATV320 drive, CANopen communication via the RJ45 communication port is disabled.

(4) Please refer to the "Modicon M241 logic controller" and "Modicon M251 logic controller" catalogs.

(5) Cable dependent on the type of controller or PLC; please refer to the corresponding catalog.

(6) See page 34 for item "6".

(7) Altivar Machine ATV320 products with a compact control block require the **VW3A3600** option module adapter in order to use any communication option modules.



VW3A3616

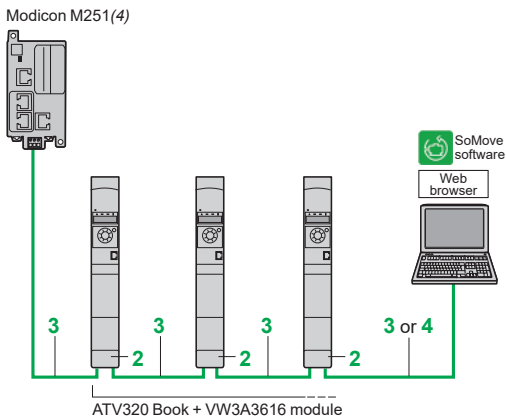
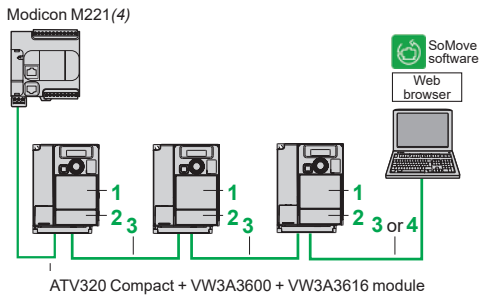

Example of connection on an EtherNet/IP network

Modbus TCP network and EtherNet/IP network (1) (5)

Description	Item no.	Length m/ft (3)	Reference	Weight kg/lb
-------------	----------	-----------------	-----------	--------------

Communication module

Modbus TCP and EtherNet/IP network module	2	–	VW3A3616	0.300/ 0.661
--	----------	---	-----------------	-----------------

For connection to the Modbus TCP network or EtherNet/IP network
 Ports: 2 RJ45 connectors
 ■ 10/100 Mbps, half duplex and full duplex
 ■ Embedded web server

Requires cordsets
 490NTW000●●/●●U or
 490NTC000●●/●●U

ConneXium cordsets (2) (3)

Straight shielded twisted pair cordsets	3	2.0/ 6.56	490NTW00002	–
equipped with 2 RJ45 connectors		5.0/ 16.40	490NTW00005	–
Conforming to EIA/TIA-568 category 5 and IEC 11801/EN 50173-1, class D standards		12/ 39.37	490NTW00012	–

Crossed shielded twisted pair cordsets	4	5.0/ 16.40	490NTC00005	–
equipped with 2 RJ45 connectors		15/ 49.21	490NTC00015	–
Conforming to EIA/TIA-568 category 5 and IEC 11801/EN 50173-1, class D standards				

Straight shielded twisted pair cables	3	2.0/ 6.56	490NTW00002U	–
equipped with 2 RJ45 connectors		5.0/ 16.40	490NTW00005U	–
Conforming to UL and CSA 22.1 standards		12/ 39.37	490NTW00012U	–

Crossed shielded twisted pair cordsets	3	5.0/ 16.40	490NTC00005U	–
equipped with 2 RJ45 connectors		15/ 49.21	490NTC00015U	–
Conforming to UL and CSA 22.1 standards				

- (1) The Altivar Machine ATV320 drive can only take one communication module.
- (2) For other ConneXium connection accessories, please refer to our website www.schneider-electric.com.
- (3) Also available in 40 m/131.23 ft and 80 m/262.46 ft lengths (2).
- (4) Please refer to the "M221/M241/M251 Automation platform" catalog.
- (5) Altivar Machine ATV320 products with a compact control block require the **VW3A3600** option module adapter (item 1) in order to use any communication option modules.

Variable speed drives

Altivar Machine ATV320

Communication buses and networks



VW3A3607

PROFIBUS DP V1 bus (1)(2)

Description	Reference	Weight kg/lb
PROFIBUS DP V1 communication module Port: 1 x 9-way female SUB-D connector Conforming to PROFIBUS DP V1 Profiles supported: ■ CiA 402 drive ■ Profidrive Offers several message handling modes based on DP V1	VW3A3607	0.140/ 0.308

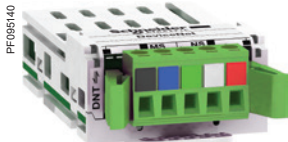

VW3A3609

DeviceNet bus (1)(2)

Description	Reference	Weight kg/lb
DeviceNet communication module Port: 1 removable 5-way screw connector Profiles supported: ■ CIP AC DRIVE ■ CiA 402 drive	VW3A3609	—



VW3A3601

EtherCAT bus (1)(2)

Description	Reference	Weight kg/lb
EtherCAT communication module Port: 2 RJ45 connectors	VW3A3601	—



VW3A3619

POWERLINK network (1)(2)

Description	Reference	Weight kg/lb
Ethernet POWERLINK communication module Port: 2 RJ45 connectors	VW3A3619	0.300/ 0.660



VW3A3627

ProfiNet network (1)(2)

Description	Reference	Weight kg/lb
ProfiNet communication module Port: 2 RJ45 connectors	VW3A3627	0.300/ 0.660

(1) The Altivar Machine ATV320 drive can only take one communication module.

(2) Altivar Machine ATV320 products with a compact control block require the **VW3A3600** option module adapter in order to use any communication option modules.

Applications

Two types of combination are possible:

■ Circuit breaker + drive: minimum combination. The circuit breaker can be mounted directly on **ATV320●●●M●●** and **ATV320U04N4B...U40N4B** drives using the bracket for GV2/ATV320 direct mounting (**VW3A9921**) and the adapter plate (**GV2AF5**) (see page 14).

■ Circuit breaker + contactor + drive: minimum combination with contactor when a control circuit is needed.

The circuit breaker provides protection against accidental short circuits, disconnection, and, if necessary, isolation.

The contactor controls and manages any protection functions. A contactor can be used downstream of the drive to help ensure the motor is isolated on stopping. In this case, the contactor size should be category AC-3 depending on the associated motor, only for operation between 25 Hz and 500 Hz.

The Altivar Machine ATV320 drive is protected electronically against short circuits between phases and between phase and ground. It therefore provides continuity of service and thermal monitoring of the motor.

Motor starters: Circuit breaker + Drive

Standard power ratings of three-phase 4-pole 50/60 Hz motors (2)		Variable speed drive Reference (3)	Circuit breaker (1) Reference	Circuit breaker mounted directly on ATV320 (4)
kW	HP			
Single-phase supply voltage: 200...240 V 50/60 Hz				
0.18	0.25	ATV320U02M2●	GV2L08 (5)	With accessories VW3A9921 + GV2AF5 (6)
0.37	0.5	ATV320U04M2●	GV2L10 (5)	
0.55	0.75	ATV320U06M2●	GV2L14 (5)	
0.75	1	ATV320U07M2●	GV2L16 (5)	
1.1	1.5	ATV320U11M2●	GV2L16 (5)	
1.5	2	ATV320U15M2●	GV2L20 (5)	
2.2	3	ATV320U22M2●	GV2L22 (5)	
Three-phase supply voltage: 200...240 V 50/60 Hz				
0.18	0.25	ATV320U02M3C	GV2L07 (5)	–
0.37	0.5	ATV320U04M3C	GV2L08 (5)	
0.55	0.75	ATV320U06M3C	GV2L10 (5)	
0.75	1	ATV320U07M3C	GV2L14 (5)	
1.1	1.5	ATV320U11M3C	GV2L14 (5)	
1.5	2	ATV320U15M3C	GV2L16 (5)	
2.2	3	ATV320U22M3C	GV2L20 (5)	
3	4	ATV320U30M3C	GV2L22 (5)	
4	5	ATV320U40M3C	GV2L22 (5)	
5.5	7.5	ATV320U55M3C	GV3L40 (5)	
7.5	10	ATV320U75M3C	GV3L50 (5)	
11	15	ATV320D11M3C	GV3L65 (5)	
15	20	ATV320D15M3C	NS100HMA	
Three-phase supply voltage: 380...500 V 50/60 Hz				
0.37	0.5	ATV320U04N4●	GV2L07 (5) (7)	With accessories VW3A9921 + GV2AF5 (6)
0.55	0.75	ATV320U06N4●	GV2L08 (5) (7)	
0.75	1	ATV320U07N4●	GV2L08 (5) (7)	
1.1	1.5	ATV320U11N4●	GV2L10 (5) (7)	
1.5	2	ATV320U15N4●	GV2L14 (5) (7)	
2.2	3	ATV320U22N4●	GV2L14 (5) (7)	
3	4	ATV320U30N4●	GV2L16 (5) (7)	
4	5	ATV320U40N4●	GV2L16 (5) (7)	
5.5	7.5	ATV320U55N4B	GV2L22 (5)	–
7.5	10	ATV320U75N4B	GV3L32 (5)	
11	15	ATV320D11N4B	GV3L40 (5)	
15	20	ATV320D15N4B	GV3L50 (5)	
Three-phase supply voltage: 525...600 V 50/60 Hz				
0.75	1	ATV320U07S6C	GV3P13	–
1.5	2	ATV320U15S6C	GV3P13	
2.2	3	ATV320U22S6C	GV3P13	
4	5	ATV320U40S6C	GV3P13	
5.5	7.5	ATV320U55S6C	GV3P13	
7.5	10	ATV320U75S6C	GV3P18	
11	15	ATV320D11S6C	GV3P25	
15	20	ATV320D15S6C	GV3P32	

(1) GV2L, GV3L: TeSys magnetic motor circuit breakers; accessories (see page 41).

(2) The HP values given are NEC-compliant (National Electrical Code).

(3) For the complete reference, replace ● with B or C.

(4) The circuit breaker can be mounted directly only on the book format drive **ATV320U●●M2B** and **ATV320U04N4B...U40N4B**.

(5) **GV●L●●** circuit breaker reference are not UL compliant. To achieve UL Type E compliance **GV●P●●** thermal magnetic circuit breaker must be used.

(6) To be ordered separately (see page 13), see note (4) for compatibility.

(7) A GV2P TeSys thermal magnetic circuit breaker with the same rating can also be used with **ATV320U04N4●...U40N4●** drives. The thermal release should then be set to maximum to inhibit this function.



GV2 / ATV320 direct mounting: **GV2L08 + (VW3A9921 + GV2AF5) (5) (6) + ATV320U07N4B**



ATV320U07S6C

Variable speed drives

Altivar Machine ATV320

Motor starters: circuit breaker + contactor + drive



GV2L14 + LC1D09 + ATV320U15N4B / ATV320U04N4C

Motor starters: Circuit breaker + Contactor + Drive

Standard power rating of 50/60 Hz 4-pole motors (3)		Variable speed drive Reference (4)	Circuit breaker (1) Reference	Contactor (2) Reference (5)
kW	HP			
Single-phase supply voltage: 200...240 V 50/60 Hz				
0.18	0.25	ATV320U02M2●	GV2L08 (6)	LC1D09●●
0.37	0.5	ATV320U04M2●	GV2L10 (6)	LC1D09●●
0.55	0.75	ATV320U06M2●	GV2L14 (6)	LC1D09●●
0.75	1	ATV320U07M2●	GV2L16 (6)	LC1D09●●
1.1	1.5	ATV320U11M2●	GV2L16 (6)	LC1D09●●
1.5	2	ATV320U15M2●	GV2L20 (6)	LC1D09●●
2.2	3	ATV320U22M2●	GV2L22 (6)	LC1D09●●
Three-phase supply voltage: 200...240 V 50/60 Hz				
0.18	0.25	ATV320U02M3C	GV2L07 (6)	LC1D09●●
0.37	0.5	ATV320U04M3C	GV2L08 (6)	LC1D09●●
0.55	0.75	ATV320U06M3C	GV2L10 (6)	LC1D09●●
0.75	1	ATV320U07M3C	GV2L14 (6)	LC1D09●●
1.1	1.5	ATV320U11M3C	GV2L14 (6)	LC1D09●●
1.5	2	ATV320U15M3C	GV2L16 (6)	LC1D09●●
2.2	3	ATV320U22M3C	GV2L20 (6)	LC1D09●●
3	4	ATV320U30M3C	GV2L22 (6)	LC1D09●●
4	5	ATV320U40M3C	GV2L22 (6)	LC1D09●●
5.5	7.5	ATV320U55M3C	GV3L40 (6)	LC1D09●●
7.5	10	ATV320U75M3C	GV3L50 (6)	LC1D18●●
11	15	ATV320D11M3C	GV3L65 (6)	LC1D25●●
15	20	ATV320D15M3C	NS100HMA	LC1D32●●
Three-phase supply voltage: 380...500 V 50/60 Hz				
0.37	0.5	ATV320U04N4●	GV2L07 (6)	LC1D09●●
0.55	0.75	ATV320U06N4●	GV2L08 (6)	LC1D09●●
0.75	1	ATV320U07N4●	GV2L08 (6)	LC1D09●●
1.1	1.5	ATV320U11N4●	GV2L10 (6)	LC1D09●●
1.5	2	ATV320U15N4●	GV2L14 (6)	LC1D09●●
2.2	3	ATV320U22N4●	GV2L14 (6)	LC1D09●●
3	4	ATV320U30N4●	GV2L16 (6)	LC1D09●●
4	5	ATV320U40N4●	GV2L16 (6)	LC1D09●●
5.5	7.5	ATV320U55N4B	GV2L22 (6)	LC1D09●●
7.5	10	ATV320U75N4B	GV3L32 (6)	LC1D18●●
11	15	ATV320D11N4B	GV3L40 (6)	LC1D25●●
15	20	ATV320D15N4B	GV3L50 (6)	LC1D32●●
Three-phase supply voltage: 525...600 V 50/60 Hz				
0.75	1	ATV320U07S6C	GV3P13	LC1D09●●
1.5	2	ATV320U15S6C	GV3P13	LC1D09●●
2.2	3	ATV320U22S6C	GV3P13	LC1D09●●
4	5	ATV320U40S6C	GV3P13	LC1D09●●
5.5	7.5	ATV320U55S6C	GV3P13	LC1D09●●
7.5	10	ATV320U75S6C	GV3P18	LC1D09●●
11	15	ATV320D11S6C	GV3P25	LC1D18●●
15	20	ATV320D15S6C	GV3P32	LC1D25●●

(1) GV2L, GV3L: TeSys magnetic motor circuit breakers; accessories (see page 41).

(2) Composition of TeSys contactors LC1D09/D18/D25/D32: 3 poles + 1 NO auxiliary contact + 1 NC auxiliary contact.

(3) The HP values given are NEC-compliant (National Electrical Code).

(4) For the complete reference, replace ● with B or C.

(5) Replace ●● with the control circuit voltage reference given in the table below:

AC control circuit	Volts ~					
	24	48	115	230	230/240	
LC1D	50/60 Hz	B7	E7	FE7	P7	U7

For other voltages between 24 V and 660 V, or a DC control circuit, please refer to the "Motor starter solutions - Control and protection components" catalog or visit our web site: www.schneider-electric.com.

(6) GV●L●● circuit breaker reference are not UL compliant. To achieve UL Type E compliance GV●P●● thermal magnetic circuit breaker must be used.

Accessories for TeSys circuit breakers (1)

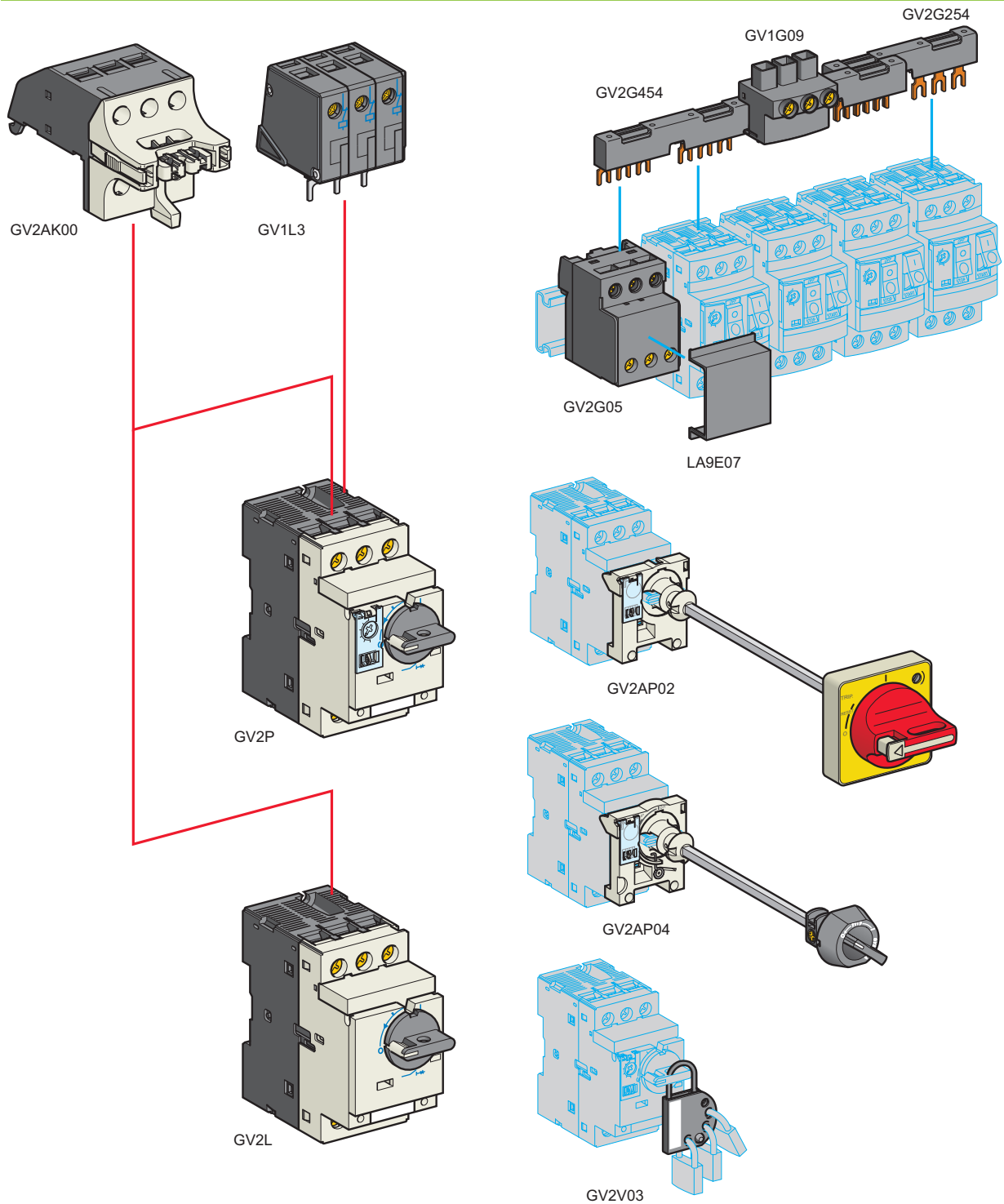

(1) Example of accessories available; see page 41 for full product references.

Variable speed drives

Altivar Machine ATV320

Accessories for TeSys circuit breakers

ATV320_63A40_OPF16049



Example of GV2/ATV320 direct mounting in an enclosure: GV2L circuit breakers + GV2454 and GV2G05 accessories + ATV320U15N4B drives

Accessories for TeSys circuit breakers (continued) (1)			
Description	For circuit breaker	Unit reference	Weight kg/lb
Add-on blocks			
Visible isolation block (2) Max. number: 1	Mounted on front	GV2L07...L22, GV2P07...P22	GV2AK00 0.150/ 0.331
Limiters Max. number: 1	Mounted on the top	GV2P	GV1L3 0.130/ 0.287
	Separate	GV2L/GV2P	LA9LB920 0.320/ 0.705
Busbars			
3-pole busbars 63 A, 2 tap links	45 mm/1.77 in. interval	GV2L/GV2P	GV2G245 0.036/ 0.079
	54 mm/2.13 in. interval	GV2L/GV2P	GV2G254 0.038/ 0.084
	72 mm/2.83 in. interval	GV2L/GV2P	GV2G272 0.042/ 0.093
3-pole busbars 63 A, 3 tap links	45 mm/1.77 in. interval	GV2L/GV2P	GV2G345 0.058/ 0.128
	54 mm/2.13 in. interval	GV2L/GV2P	GV2G354 0.060/ 0.132
3-pole busbars 63 A, 4 tap links	45 mm/1.77 in. interval	GV2L/GV2P	GV2G445 0.077/ 0.170
	54 mm/2.13 in. interval	GV2L/GV2P	GV2G454 0.085/ 0.187
	72 mm/2.83 in. interval	GV2L/GV2P	GV2G472 0.094/ 0.207
3-pole busbars 63 A, 5 tap links	54 mm/2.13 in. interval	GV2L/GV2P	GV2G554 0.100/ 0.220
Terminal blocks For supplying one or more busbars GV2G●●●	Connection at the top	GV2L/GV2P	GV1G09 0.040/ 0.088
	Can take the GV1L3 limiter	GV2P	GV2G05 0.115/ 0.253
Protective end cover For busbar output awaiting extension <i>(sold in lots of 5)</i>		GV2L/GV2P	GV1G10 0.005/ 0.011
Cover for terminal block For mounting in modular distribution boards <i>(sold in lots of 10)</i>		GV2L/GV2P	LA9E07 0.005/ 0.011
Adapter			
Large spacing adapter UL 508 type E		GV2P07...P022	GV2GH7 0.040/ 0.088
External controls			
External control Max. enclosure depth 290 mm/11.41 in. Visual OFF indication Red handle, yellow front plate, IP 54 Can be locked with padlock (not supplied)		GV2L, GV2P	GV2AP02 0.200/ 0.441
External control Max. enclosure depth 290 mm/11.41 in. No visual ON/OFF indication Does not lock the door or plug-in base opening control mechanism in the ON position Color: RAL 7016, IP 54		GV2L, GV2P	GV2AP04 0.104/ 0.229
External control Max. enclosure depth 390 mm/15.35 in. Includes: A handle LU9AP1●, a rod 260 mm/10.24 in. maximum, a bracket and an adapter. Visual OFF indication Red handle, yellow front plate, IP 54 Can be locked with padlock (not supplied)		GV3L, GV3P	GV3AP02 0.294/ 0.648
Padlocking device			
Padlocking device Can take 4 padlocks (not supplied) ∅ 6 mm/0.24 in. max.		GV2L, GV2P GV3L, GV3P	GV2V03 0.092/ 0.203

(1) For a detailed description and other accessories for circuit breakers, please refer to the "Motor starter solutions - Control and protection components" catalog or visit www.schneider-electric.com.

(2) 3 poles isolated upstream of GV2L and GV2P circuit breakers.

Variable speed drives

Altivar Machine ATV320

Drives with compact control block

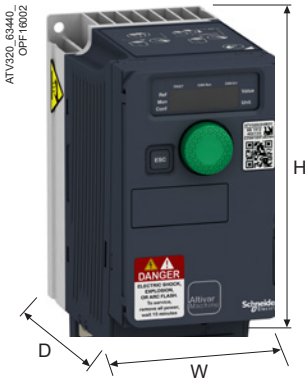

Drives with compact control block

Single-phase supply voltage: 200...240 V 50/60 Hz

Drives	W x H x D (1)	
	mm	in.
ATV320U02M2C	72 x 143 x 109	2.83 x 5.63 x 4.29
With EMC plate	72 x 188 x 109	2.83 x 7.40 x 4.29
With UL Type 1 conformity kit	72 x 195.5 x 109	2.83 x 7.70 x 4.29
ATV320U04M2C	72 x 143 x 128	2.83 x 5.63 x 5.04
With EMC plate	72 x 188 x 128	2.83 x 7.40 x 5.04
With UL Type 1 conformity kit	72 x 195.5 x 128	2.83 x 7.70 x 5.04
ATV320U06M2C	72 x 143 x 138	2.83 x 5.63 x 5.43
With EMC plate	72 x 188 x 138	2.83 x 7.40 x 5.43
With UL Type 1 conformity kit	72 x 195.5 x 138	2.83 x 7.70 x 5.43
ATV320U07M2C	72 x 143 x 138	2.83 x 5.63 x 5.43
With EMC plate	72 x 188 x 138	2.83 x 7.40 x 5.43
With UL Type 1 conformity kit	72 x 195.5 x 138	2.83 x 7.70 x 5.43
ATV320U11M2C	105 x 142 x 158	4.13 x 5.60 x 6.22
With EMC plate	105 x 188 x 158	4.13 x 7.40 x 6.22
With UL Type 1 conformity kit	105 x 210.5 x 158	4.13 x 8.29 x 6.22
ATV320U15M2C	105 x 142 x 158	4.13 x 5.60 x 6.22
With EMC plate	105 x 188 x 158	4.13 x 7.40 x 6.22
With UL Type 1 conformity kit	105 x 210.5 x 158	4.13 x 8.29 x 6.22
ATV320U22M2C	105 x 142 x 158	4.13 x 5.60 x 6.22
With EMC plate	105 x 188 x 158	4.13 x 7.40 x 6.22
With UL Type 1 conformity kit	105 x 210.5 x 158	4.13 x 8.29 x 6.22

Three-phase supply voltage: 380...500 V 50/60 Hz

Drives	W x H x D (1)	
	mm	in.
ATV320U04N4C	105 x 143 x 158	4.13 x 5.63 x 6.22
With EMC plate	105 x 188 x 158	4.13 x 7.40 x 6.22
With UL Type 1 conformity kit	105 x 210.5 x 158	4.13 x 8.29 x 6.22
ATV320U06N4C	105 x 143 x 158	4.13 x 5.63 x 6.22
With EMC plate	105 x 188 x 158	4.13 x 7.40 x 6.22
With UL Type 1 conformity kit	105 x 210.5 x 158	4.13 x 8.29 x 6.22
ATV320U07N4C	105 x 143 x 158	4.13 x 5.63 x 6.22
With EMC plate	105 x 188 x 158	4.13 x 7.40 x 6.22
With UL Type 1 conformity kit	105 x 210.5 x 158	4.13 x 8.29 x 6.22
ATV320U11N4C	105 x 143 x 158	4.13 x 5.63 x 6.22
With EMC plate	105 x 188 x 158	4.13 x 7.40 x 6.22
With UL Type 1 conformity kit	105 x 210.5 x 158	4.13 x 8.29 x 6.22
ATV320U15N4C	105 x 143 x 158	4.13 x 5.63 x 6.22
With EMC plate	105 x 188 x 158	4.13 x 7.40 x 6.22
With UL Type 1 conformity kit	105 x 210.5 x 158	4.13 x 8.29 x 6.22
ATV320U22N4C	140 x 184 x 158	5.51 x 7.24 x 6.22
With EMC plate	140 x 227.9 x 158	5.51 x 8.97 x 6.22
With UL Type 1 conformity kit	140 x 236.5 x 158	5.51 x 9.31 x 6.22
ATV320U30N4C	140 x 184 x 158	5.51 x 7.24 x 6.22
With EMC plate	140 x 227.9 x 158	5.51 x 8.97 x 6.22
With UL Type 1 conformity kit	140 x 236.5 x 158	5.51 x 9.31 x 6.22
ATV320U40N4C	140 x 184 x 158	5.51 x 7.24 x 6.22
With EMC plate	140 x 227.9 x 158	5.51 x 8.97 x 6.22
With UL Type 1 conformity kit	140 x 236.5 x 158	5.51 x 9.31 x 6.22

(1) The total depth excludes the module adapter, + 20 mm/0.79 in. in depth if combined with the option module adapter.



Drives with compact control block

Three-phase supply voltage: 200...240 V 50/60 Hz

Drives	W x H x D (1)	
	mm	in.
ATV320U02M3C	72 x 143 x 109	2.83 x 5.63 x 4.29
With EMC plate	72 x 188 x 109	2.83 x 7.40 x 4.29
With UL Type 1 conformity kit	72 x 195.5 x 109	2.83 x 7.70 x 4.29
ATV320U04M3C	72 x 143 x 128	2.83 x 5.63 x 5.04
With EMC plate	72 x 188 x 128	2.83 x 7.40 x 5.04
With UL Type 1 conformity kit	72 x 195.5 x 128	2.83 x 7.70 x 5.04
ATV320U06M3C	72 x 143 x 138	2.83 x 5.63 x 5.43
With EMC plate	72 x 188 x 138	2.83 x 7.40 x 5.43
With UL Type 1 conformity kit	72 x 195.5 x 138	2.83 x 7.70 x 5.43
ATV320U07M3C	72 x 143 x 138	2.83 x 5.63 x 5.43
With EMC plate	72 x 188 x 138	2.83 x 7.40 x 5.43
With UL Type 1 conformity kit	72 x 195.5 x 138	2.83 x 7.70 x 5.43
ATV320U11M3C	105 x 143 x 138	4.13 x 5.63 x 5.43
With EMC plate	105 x 190 x 138	4.13 x 7.48 x 5.43
With UL Type 1 conformity kit	105 x 210.5 x 138	4.13 x 8.29 x 5.43
ATV320U15M3C	105 x 143 x 138	4.13 x 5.63 x 5.43
With EMC plate	105 x 190 x 138	4.13 x 7.48 x 5.43
With UL Type 1 conformity kit	105 x 210.5 x 138	4.13 x 8.29 x 5.43
ATV320U22M3C	105 x 143 x 138	4.13 x 5.63 x 5.43
With EMC plate	105 x 190 x 138	4.13 x 7.48 x 5.43
With UL Type 1 conformity kit	105 x 210.5 x 138	4.13 x 8.29 x 5.43
ATV320U30M3C	140 x 184 x 158	5.51 x 7.24 x 6.22
With EMC plate	140 x 228 x 158	5.51 x 8.98 x 6.22
With UL Type 1 conformity kit	140 x 236.5 x 158	5.51 x 9.31 x 6.22
ATV320U40M3C	140 x 184 x 158	5.51 x 7.24 x 6.22
With EMC plate	140 x 228 x 158	5.51 x 8.98 x 6.22
With UL Type 1 conformity kit	140 x 236.5 x 158	5.51 x 9.31 x 6.22
ATV320U55M3C	150 x 232 x 178	5.91 x 9.13 x 7.01
With EMC plate	150 x 308 x 178	5.91 x 21.13 x 7.01
With UL Type 1 conformity kit	150 x 316 x 178	5.91 x 12.44 x 7.01
ATV320U75M3C	150 x 232 x 178	5.91 x 9.13 x 7.01
With EMC plate	150 x 308 x 178	5.91 x 21.13 x 7.01
With UL Type 1 conformity kit	150 x 316 x 178	5.91 x 12.44 x 7.01
ATV320D11M3C	180 x 330 x 198	7.09 x 12.99 x 7.80
With EMC plate	180 x 405 x 198	7.09 x 15.94 x 7.80
With UL Type 1 conformity kit	180 x 410.5 x 198	7.09 x 16.16 x 7.80
ATV320D15M3C	180 x 330 x 198	7.09 x 12.99 x 7.80
With EMC plate	180 x 405 x 198	7.09 x 15.94 x 7.80
With UL Type 1 conformity kit	180 x 410.5 x 198	7.09 x 16.16 x 7.80

Three-phase supply voltage: 525...600 V 50/60 Hz

ATV320U07S6C	105 x 142 x 158	4.13 x 5.59 x 6.22
With EMC plate	105 x 188 x 158	4.13 x 7.4 x 6.22
With UL Type 1 conformity kit	105 x 196 x 158	4.13 x 7.72 x 6.22
ATV320U15S6C	105 x 142 x 158	4.13 x 5.59 x 6.22
With EMC plate	105 x 188 x 158	4.13 x 7.4 x 6.22
With UL Type 1 conformity kit	105 x 196 x 158	4.13 x 7.72 x 6.22
ATV320U22S6C	140 x 184 x 158	5.51 x 7.24 x 6.22
With EMC plate	140 x 227.9 x 158	5.51 x 8.97 x 6.22
With UL Type 1 conformity kit	140 x 236.5 x 158	5.51 x 9.31 x 6.22
ATV320U40S6C	140 x 184 x 158	5.51 x 7.24 x 6.22
With EMC plate	140 x 227.9 x 158	5.51 x 8.97 x 6.22
With UL Type 1 conformity kit	140 x 236.5 x 158	5.51 x 9.31 x 6.22
ATV320U55S6C	150 x 232 x 178	5.90 x 9.13 x 7.01
With EMC plate	150 x 308 x 178	5.90 x 12.13 x 7.01
With UL Type 1 conformity kit	150 x 316 x 178	5.90 x 12.44 x 7.01
ATV320U75S6C	150 x 232 x 178	5.90 x 9.13 x 7.01
With EMC plate	150 x 308 x 178	5.90 x 12.13 x 7.01
With UL Type 1 conformity kit	150 x 316 x 178	5.90 x 12.44 x 7.01
ATV320D11S6C	180 x 330 x 198	7.08 x 12.99 x 7.79
With EMC plate	180 x 404 x 198	7.08 x 15.9 x 7.79
With UL Type 1 conformity kit	180 x 410 x 198	7.08 x 16.14 x 7.79
ATV320D15S6C	180 x 330 x 198	7.08 x 12.99 x 7.79
With EMC plate	180 x 404 x 198	7.08 x 15.9 x 7.79
With UL Type 1 conformity kit	180 x 410 x 198	7.08 x 16.14 x 7.79

(1) The total depth excludes the module adapter, + 20 mm/0.79 in. in depth if combined with the option module adapter.

Variable speed drives

Altivar Machine ATV320

Drives with book control block

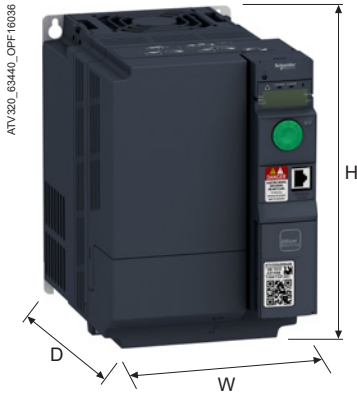

Drives with book control block

Single-phase supply voltage: 200...240 V 50/60 Hz

Drives	W x H x D	
	mm	in.
ATV320U02M2B	45 x 325 x 245	1.77 x 12.8 x 9.64
ATV320U04M2B	45 x 325 x 245	1.77 x 12.8 x 9.64
ATV320U06M2B	45 x 325 x 245	1.77 x 12.8 x 9.64
ATV320U07M2B	45 x 325 x 245	1.77 x 12.8 x 9.64
ATV320U11M2B	60 x 325 x 245	2.63 x 12.8 x 9.64
ATV320U15M2B	60 x 325 x 245	2.63 x 12.8 x 9.64
ATV320U22M2B	60 x 325 x 245	2.63 x 12.8 x 9.64

Three-phase supply voltage: 380...500 V 50/60 Hz

Drives	W x H x D	
	mm	in.
ATV320U04N4B	45 x 325 x 245	1.77 x 12.8 x 9.64
ATV320U06N4B	45 x 325 x 245	1.77 x 12.8 x 9.64
ATV320U07N4B	45 x 325 x 245	1.77 x 12.8 x 9.64
ATV320U11N4B	45 x 325 x 245	1.77 x 12.8 x 9.64
ATV320U15N4B	45 x 325 x 245	1.77 x 12.8 x 9.64
ATV320U22N4B	60 x 325 x 245	2.63 x 12.8 x 9.64
ATV320U30N4B	60 x 325 x 245	2.63 x 12.8 x 9.64
ATV320U40N4B	60 x 325 x 245	2.63 x 12.8 x 9.64
ATV320U55N4B	150 x 232 x 232	5.90 x 9.13 x 9.13
With EMC plate	150 x 308 x 232	5.90 x 12.1 x 9.13
With UL Type 1 conformity kit	155 x 314 x 240	6.10 x 12.36 x 9.45
ATV320U75N4B	150 x 232 x 232	5.90 x 9.13 x 9.13
With EMC plate	150 x 308 x 232	5.90 x 12.1 x 9.13
With UL Type 1 conformity kit	155 x 314 x 240	6.10 x 12.36 x 9.45
ATV320D11N4B	180 x 330 x 232	7.09 x 13.0 x 9.13
With EMC plate	180 x 404 x 232	7.09 x 15.9 x 9.13
With UL Type 1 conformity kit	185 x 408.5 x 250	7.28 x 16.08 x 9.84
ATV320D15N4B	180 x 330 x 232	7.09 x 13.0 x 9.13
With EMC plate	180 x 404 x 232	7.09 x 15.9 x 9.13
With UL Type 1 conformity kit	185 x 408.5 x 250	7.28 x 16.08 x 9.84

Variable speed drives

Altivar Machine ATV320

Line chokes, Motor chokes, Braking resistors,
Additional EMC input filters

Line chokes

Line chokes	W x H x D	
	mm	in.
VW3A4551	100 x 135 x 60	3.94 x 5.31 x 2.36
VW3A4552	130 x 155 x 90	5.11 x 6.10 x 3.54
VW3A4553	130 x 155 x 90	5.11 x 6.10 x 3.54
VW3A4554	155 x 170 x 135	5.90 x 6.69 x 5.31
VW3A4555	180 x 210 x 160	7.09 x 8.27 x 6.30
VZ1L007UM50	60 x 100 x 95	2.36 x 3.94 x 3.74
VZ1L018UM20	85 x 120 x 105	3.35 x 4.72 x 4.13

Motor chokes

Motor chokes	W x H x D	
	mm	in.
VW3A4552	130 x 155 x 90	5.11 x 6.10 x 3.54
VW3A4553	130 x 155 x 90	5.11 x 6.10 x 3.54
VW3A4554	155 x 170 x 135	5.90 x 6.69 x 5.31
VW3A4555	180 x 210 x 160	7.09 x 8.27 x 6.30
VW3A4556	270 x 210 x 180	10.6 x 8.27 x 7.09

Braking resistors

Braking resistors	W x H x D	
	mm	in.
VW3A7603R07	251 x 204 x 15.5	9.88 x 8.03 x 0.61
VW3A7603R30		
VW3A7604R07	257 x 204 x 30	10.11 x 8.03 x 1.18
VW3A7604R30		
VW3A7605R07	145 x 98 x 15.5	5.70 x 3.85 x 0.61
VW3A7605R30		
VW3A7606R07	251 x 204 x 15.5	9.88 x 8.03 x 0.61
VW3A7606R30		
VW3A7608R07	145 x 98 x 15.5	5.70 x 3.85 x 0.61
VW3A7608R30		
VW3A7730	105 x 295 x 100	4.13 x 11.61 x 3.94
VW3A7731	105 x 345 x 100	4.13 x 13.58 x 3.94
VW3A7732	175 x 345 x 100	6.89 x 13.58 x 3.94
VW3A7733	190 x 570 x 180	7.48 x 22.44 x 7.09
VW3A7734	250 x 490 x 180	9.84 x 19.29 x 7.09
VW3A7735	250 x 490 x 180	9.84 x 19.29 x 7.09
VW3A7736	485 x 410 x 485	19.09 x 16.14 x 19.09

Additional EMC input filters

EMC filters	W x H x D	
	mm	in.
VW3A31401	72 x 195 x 37	2.82 x 7.63 x 1.45
VW3A31402	72 x 195 x 37	2.82 x 7.63 x 1.45
VW3A31403	107 x 195 x 35	4.2 x 7.63 x 1.37
VW3A31404	107 x 195 x 42	4.2 x 7.63 x 1.65
VW3A31405	140 x 235 x 35	5.48 x 9.2 x 1.37
VW3A31406	140 x 235 x 50	5.48 x 9.2 x 1.96
VW3A31407	180 x 305 x 60	7.09 x 12.01 x 2.36
VW3A31408	245 x 395 x 80	9.65 x 15.55 x 3.15
VW3A4420	72 x 195 x 37	2.82 x 7.63 x 1.45
VW3A4421	107 x 195 x 35	4.2 x 7.63 x 1.37
VW3A4422	107 x 195 x 42	4.2 x 7.63 x 1.65
VW3A4424	180 x 305 x 60	7.05 x 11.94 x 2.35
VW3A4425	245 x 395 x 60	9.59 x 15.46 x 2.35
VW3A4426	140 x 235 x 35	5.48 x 9.2 x 1.37

Variable speed drives

Altivar Machine ATV320

Product reference index

4							
490NTC00005	36	ATV320U55S6C	12	VW3A4424	29	VW3A95816	15
490NTC00005U	36	ATV320U75M3C	12	VW3A4425	29	VW3A95817	15
490NTC00015	36	ATV320U75N4B	13	VW3A4426	29	VW3A95818	15
490NTC00015U	36	ATV320U75S6C	12	VW3A4551	26	VW3A95819	15
490NTW00002	36			VW3A4552	26	VW3CANCARR1	34
490NTW00002U	36	G			27	VW3CANCARR03	34
490NTW00005	36	GV2AF5	14	VW3A4553	26	VW3CANTAP2	35
490NTW00005U	36				27	VW3M2207	14
490NTW00012	36	L		VW3A4554	26	VW3M7101R01	14
490NTW00012U	36	LU9GC3	19		27	VW3M7102R150	14
				VW3A4555	26	VY1F32AB1001	15
		T			27	VY1F10007V21	15
A		TCSCAR01NM120	35	VW3A4556	27	VZ1L007UM50	26
ATV320D11M3C	12	TCSCAR013M120	34	VW3A7603R07	25	VZ1L018UM20	26
ATV320D11N4B	13	TCSMCNAM3M002P	17	VW3A7603R30	25	VZ3V32A100	15
ATV320D11S6C	12	TM200RSRCEMC	14	VW3A7604R07	25	VZ3V32B100	15
ATV320D15M3C	12	TSXCANCA50	34	VW3A7604R30	25	VZ3V32C100	15
ATV320D15N4B	13	TSXCANCA100	34	VW3A7605R07	25	VZ3V32D100	15
ATV320D15S6C	12	TSXCANCA300	34	VW3A7605R30	25	VZ3V303S2001	15
ATV320U02M2B	13	TSXCANCADD1	35	VW3A7606R07	25	VZ3V303S3001	15
ATV320U02M2C	12	TSXCANCADD03	35	VW3A7606R30	25	VZ3V1302	15
ATV320U02M3C	12	TSXCANCADD3	35	VW3A7608R07	25		
ATV320U04M2B	13	TSXCANCADD5	35	VW3A7608R30	25		
ATV320U04M2C	12	TSXCANCB50	34	VW3A7730	24		
ATV320U04M3C	12	TSXCANCB100	34	VW3A7731	24		
ATV320U04N4B	13	TSXCANCB300	34	VW3A7732	24		
ATV320U04N4C	12	TSXCANCBDD1	35	VW3A7733	24		
ATV320U06M2B	13	TSXCANCBDD03	35	VW3A7734	24		
ATV320U06M2C	12	TSXCANCBDD3	35	VW3A7735	24		
ATV320U06M3C	12	TSXCANCBDD5	35	VW3A7736	24		
ATV320U06N4B	13	TSXCANCD50	34	VW3A8120	17		
ATV320U06N4C	12	TSXCANCD100	34	VW3A8121	17		
ATV320U07M2B	13	TSXCANCD300	34	VW3A8126	17		
ATV320U07M2C	12	TSXCANKCDF90T	34	VW3A8306R03	19		
ATV320U07M3C	12	TSXCANKCDF180T	34		33		
ATV320U07N4B	13	TSXCANTDM4	35	VW3A8306R10	19		
ATV320U07N4C	12				33		
ATV320U07S6C	12	V		VW3A8306R30	19		
ATV320U11M2B	13	VW3A1006	18		33		
ATV320U11M2C	12	VW3A1007	18	VW3A8306RC	19		
ATV320U11M3C	12	VW3A1101	19	VW3A8306TF03	19		
ATV320U11N4B	13	VW3A1102	19	VW3A8306TF10	19		
ATV320U11N4C	12	VW3A1103	19	VW3A9523	15		
ATV320U15M2B	13	VW3A1104R10	18	VW3A9524	15		
ATV320U15M2C	12		19	VW3A9525	15		
ATV320U15M3C	12	VW3A1104R30	18	VW3A9532	15		
ATV320U15N4B	13		19	VW3A9533	15		
ATV320U15N4C	12	VW3A1104R50	19	VW3A9804	14		
ATV320U15S6C	12	VW3A1104R100	19	VW3A9805	14		
ATV320U22M2B	13	VW3A1105	19	VW3A9920	14		
ATV320U22M2C	12	VW3A3600	30	VW3A9921	14		
ATV320U22M3C	12	VW3A3601	37	VW3A31401	29		
ATV320U22N4B	13	VW3A3607	37	VW3A31402	29		
ATV320U22N4C	12	VW3A3608	34	VW3A31403	29		
ATV320U22S6C	12	VW3A3609	37	VW3A31404	29		
ATV320U30M3C	12	VW3A3616	36	VW3A31405	29		
ATV320U30N4B	13	VW3A3618	34	VW3A31406	29		
ATV320U30N4C	12	VW3A3619	37	VW3A31407	29		
ATV320U40M3C	12	VW3A3620	21	VW3A31408	29		
ATV320U40N4B	13		31	VW3A36201	15		
ATV320U40N4C	12	VW3A3627	37	VW3A95811	15		
ATV320U40S6C	12	VW3A3628	35	VW3A95812	15		
ATV320U55M3C	12	VW3A4420	29	VW3A95813	15		
ATV320U55N4B	13	VW3A4421	29	VW3A95814	15		
		VW3A4422	29	VW3A95815	15		

Allivar drives



Schneider Electric Industries SAS

Head Office
35, rue Joseph Monier
F-92500 Rueil-Malmaison
France

www.schneider-electric.com/drives

The information provided in this documentation contains general descriptions and/or technical characteristics of the performance of the products contained herein. This documentation is not intended as a substitute for and is not to be used for determining suitability or reliability of these products for specific user applications. It is the duty of any such user or integrator to perform the appropriate and complete risk analysis, evaluation and testing of the products with respect to the relevant specific application or use thereof. Neither Schneider Electric nor any of its affiliates or subsidiaries shall be responsible or liable for misuse of the information contained herein.

Design: Schneider Electric
Photos: Schneider Electric