

ATS8P Series

Power-OFF Delay Timer, compact size W38×H42mm

■ Features

- Control time range
(ATS8P-□S : 0.1 to 10sec, ATS8P-□M : 0.1 to 10min)
- Direct reading for time setting and time range with easy adjustment
- Power supply: 100-120VAC 50/60Hz, 200-240VAC 50/60Hz,
24VAC 50/60Hz / 24VDC universal
- Close and DIN rail mounting
with a dedicated socket (PS-M8) width 41mm
- Easy mounting and installation/maintenance
with dedicated bracket for DIN 48×48mm
- Application
: Protection circuit when momentary power failure and start it again



⚠ Please read "Caution for your safety" in operation manual before using.



■ Ordering information

ATS	8	P	-	2	S
					Time unit
					Power supply
					Time operation
					Number of plug pins
					Item
				S	SEC
				M	MIN
			2	24VAC / 24VDC type	
			5	200-240VAC	
			6	100-120VAC	
		P	Power OFF Delay		
	8	8-pin plug type			
ATS	Small Analog Timer				

■ Specifications

※Sockets (PG-08, PS-08, PS-M8) are sold separately.

Model		ATS8P-□S	ATS8P-□M
Function		Power OFF Delay	
Control time setting range		0.1sec to 10sec	0.1min to 10min
Power supply		•100-120VAC 50/60Hz	•200-240VAC 50/60Hz •24VAC 50/60Hz, 24VDC universal
Allowable voltage range		90 to 110% of rated voltage	
Power consumption		•100-120VAC : 1.5VA	•200-240VAC : 1.5VA •24VAC : 0.2VA, 24VDC 0.2W
Time operation		Power OFF Start type	
Control output	Contact type	Time limit DPDT(2c)	
	Contact capacity	250VAC 3A resistive load	
Relay life cycle	Mechanical	Min. 10,000,000 operations	
	Electrical	Min. 100,000 operations (250VAC 3A resistive load)	
Repeat error		Max. ±0.2% ±10ms	
Setting error		Max. ±5% ±50ms	
Voltage error		Max. ±0.5%	
Temperature error		Max. ±2%	
Insulation resistance		100MΩ(at 500VDC megger)	
Dielectric strength		2000VAC 50/60Hz for 1 min.	
Noise resistance		±2kV the square wave noise (pulse width: 1μs) by noise simulator	
Vibration	Mechanical	0.75mm amplitude at frequency of 10 to 55Hz(for 1 min.) in each of X, Y, Z directions for 1 hour	
	Malfunction	0.5mm amplitude at frequency of 10 to 55Hz(for 1 min.) in each of X, Y, Z directions for 10 min.	
Shock	Mechanical	300m/s ² (approx. 30G) in each of X, Y, Z directions 3 times	
	Malfunction	100m/s ² (approx. 10G) in each of X, Y, Z directions 3 times	
Environment	Ambient temperature	-10 to 55°C, storage: -25 to 65°C	
	Ambient humidity	35 to 85%RH, storage: 35 to 85%RH	
Approval		CE 	
Accessory		Bracket	
Unit weight		Approx. 80g	Approx. 85g

※Environment resistance is rated at no freezing or condensation.

Small OFF Delay Timer

■ Connections

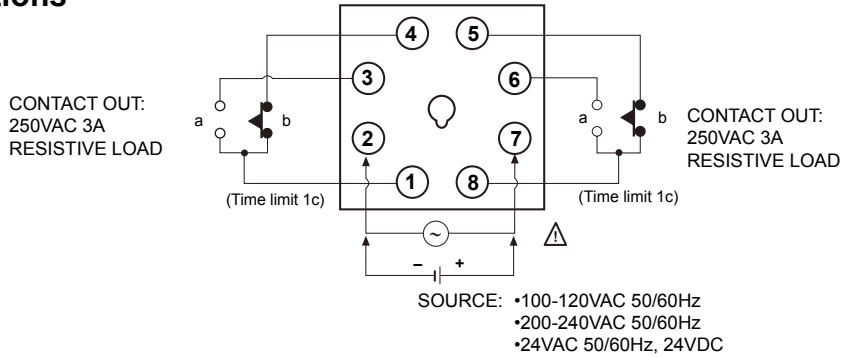

■ Dimensions

(unit : mm)

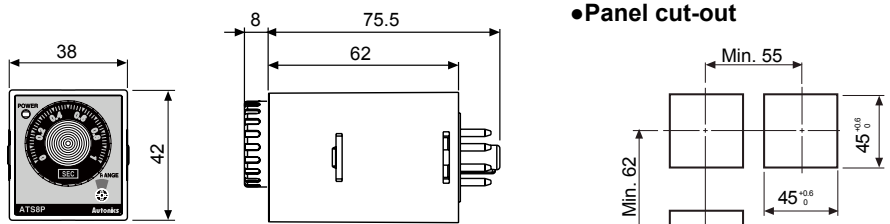

● Bracket

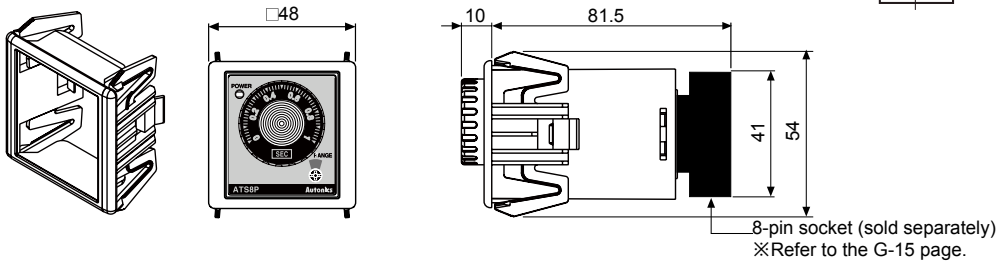

■ Parts description

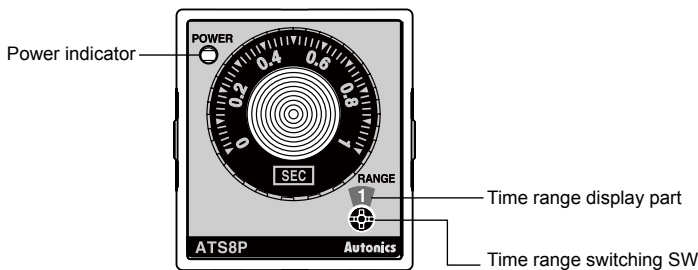

● Time specifications

	Time range	Unit	
		SEC (ATS8P-□S)	MIN (ATS8P-□M)
Setting time range(T)	1	0.1 to 1 sec	0.1 to 1 min
	10	1 to 10 sec	1 to 10 min
Min. time to supply the power		0.1sec	2sec

■ Operation

When supplying the power, 'a' contact turns ON at the same time. When turning OFF the power, 'a' contact turns OFF after the setting time (T).

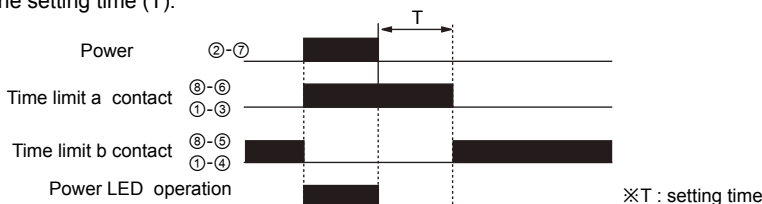

(A)	Photo electric sensor
(B)	Fiber optic sensor
(C)	Door/Area sensor
(D)	Proximity sensor
(E)	Pressure sensor
(F)	Rotary encoder
(G)	Connector/Socket
(H)	Temp. controller
(I)	SSR/ Power controller
(J)	Counter
(K)	Timer
(L)	Panel meter
(M)	Tacho/ Speed/ Pulse meter
(N)	Display unit
(O)	Sensor controller
(P)	Switching mode power supply
(Q)	Stepper motor& Driver&Controller
(R)	Graphic/ Logic panel
(S)	Field network device
(T)	Software
(U)	Other

ATS8P Series

■ Proper usage

◎ Power

- This product is Power OFF Delay Timer, the time of min. power supply is 0.1 sec. for ATS8P-□S, and 2 sec. for ATS8P-□M. Therefore be sure that this timer does not operate when supplying power but operates when turning OFF the power.

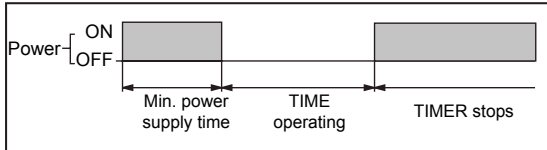

- Please observe the allowable voltage range and apply or cut the power at once to prevent from chattering.
- When supplying the power to the timer with 100-120VAC, 200-240VAC, approx. 0.5A will flow for 0.05 sec. (ATS8P-□S), 0.5 sec. (ATS8P-□M). When supplying the power to the timer with 24VDC voltage, approx. 1.5A will flow for 0.05 sec. (ATS8P-□S), 0.5 sec. (ATS8P-□M). Therefore, be sure about the rated of contact and the power capacity.

◎ Noise

- We test 2kV, pulse width 1 μ s against impulse voltage between power terminals and 1kV, pulse width 1 μ s at noise simulator against external noise voltage. Please install MP condenser (0.1 to 1 μ F) or oil condenser between power terminals when over impulse noise voltage occurs.
- Dielectric, impulse voltage or insulation resistance test of electrical circuit when this unit is installed in the control panel.
- Separate the unit from control panel circuit.
- Short circuit all terminals of the unit.
(to prevent from damage of this inner circuit by inner, insulation failure of control panel parts)

◎ Environment

Do not use this unit at below places.

- Place where temperature and humidity is out of the rated specifications.
- Place where freezing generates by temperature changes
- Place where there are flammable or explosive gas
- Place where there are lots of dust, oil or strong vibration or shock
- Place where strong alkalis or acid are used.
- Place where there are direct ray of the sun
- Place where strong magnetic field or electric noise are generated